

**DSP25**

---

**osztálytalálkozó**





## Heim-Labor

E laboratórium létrejöttében  
döntő szerepe volt

**Josef Heim**  
úr anyagi támogatásának.

Budapest, 1993. május

Für das Zustandekommen  
dieses Laboratoriums  
spielte die finanzielle  
Unterstützung von Herrn

**Josef Heim**  
eine entscheidende Rolle

Josef HEIM KG  
Bergisch Gladbach, Deutschland

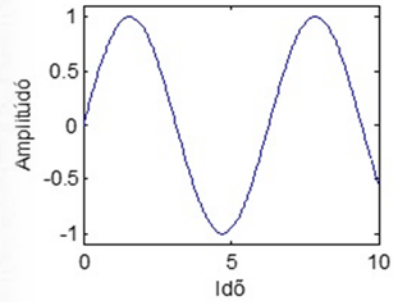

Analóg  
jelgenerálás

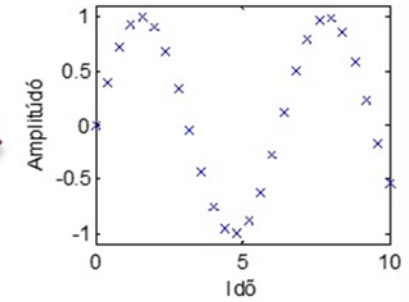
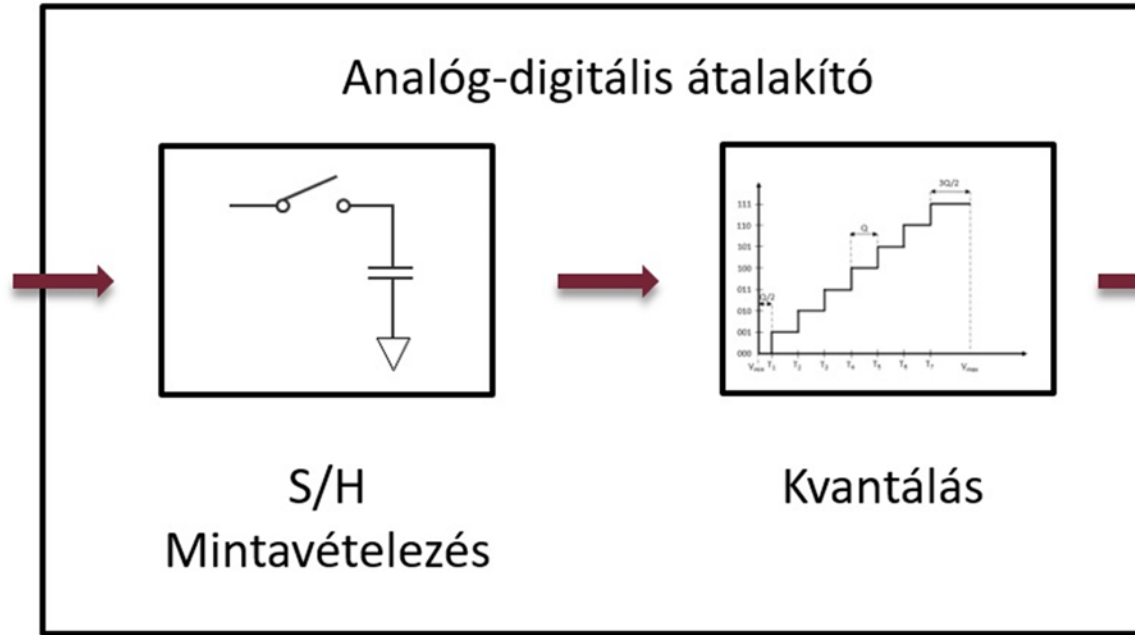

Digitális  
jelfeldolgozás



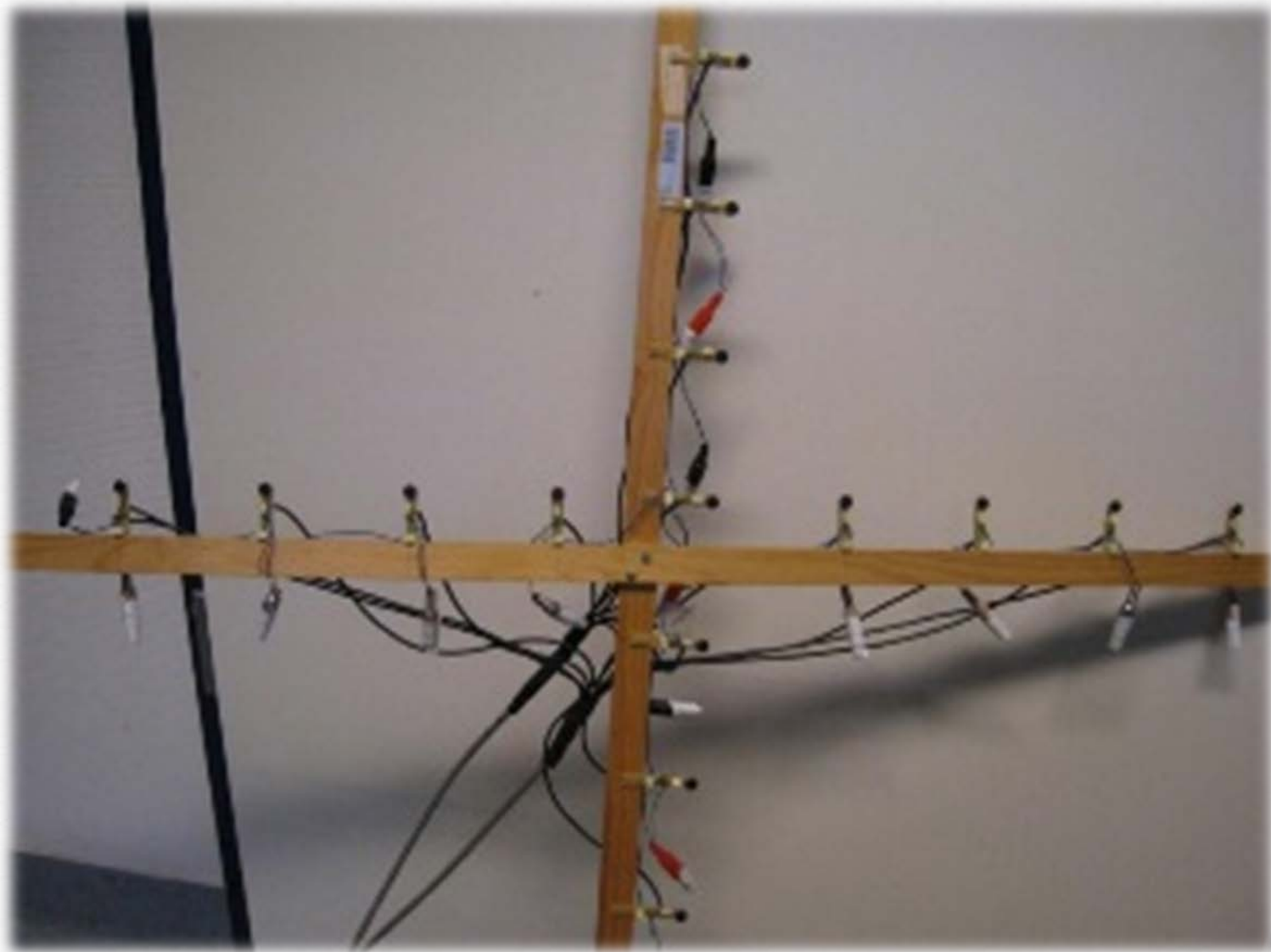



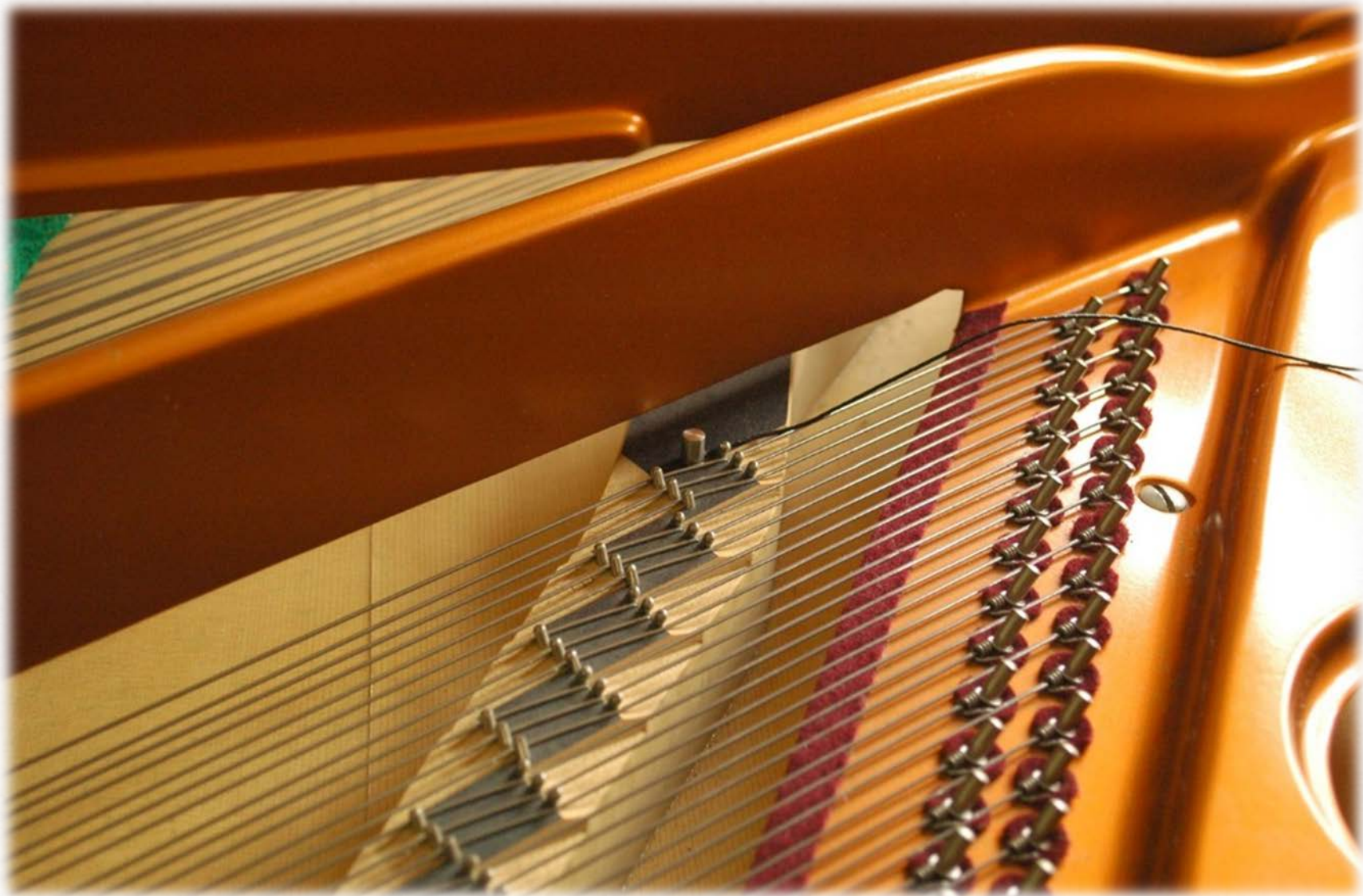









A zongora húrjaihoz  
nyúlni szigorúan  
TILOS!



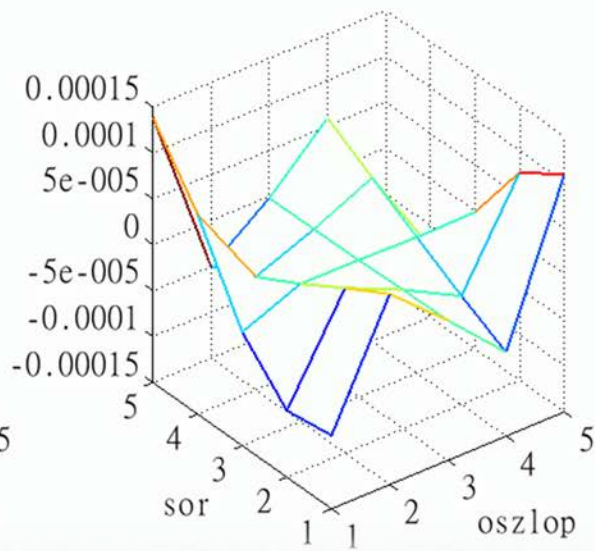
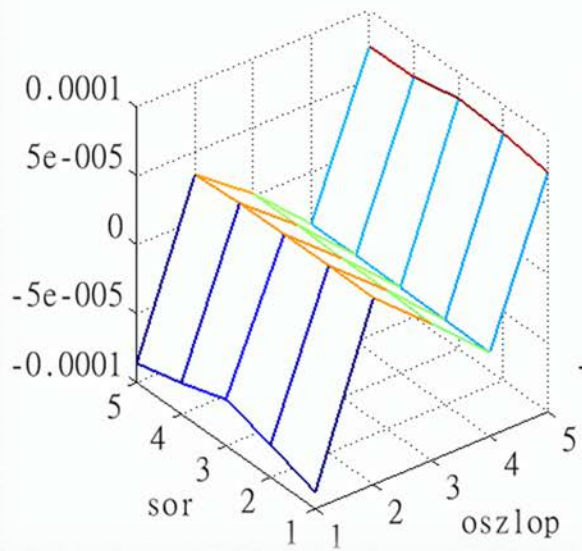
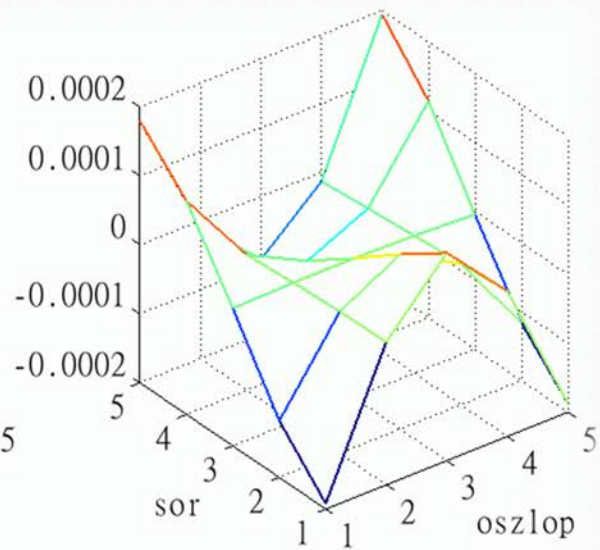
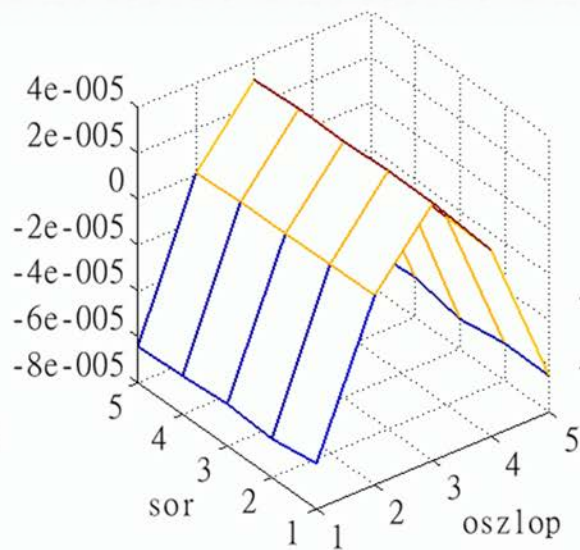
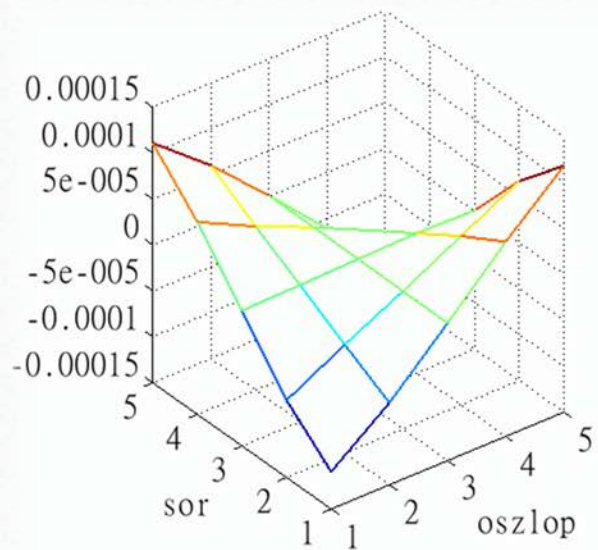



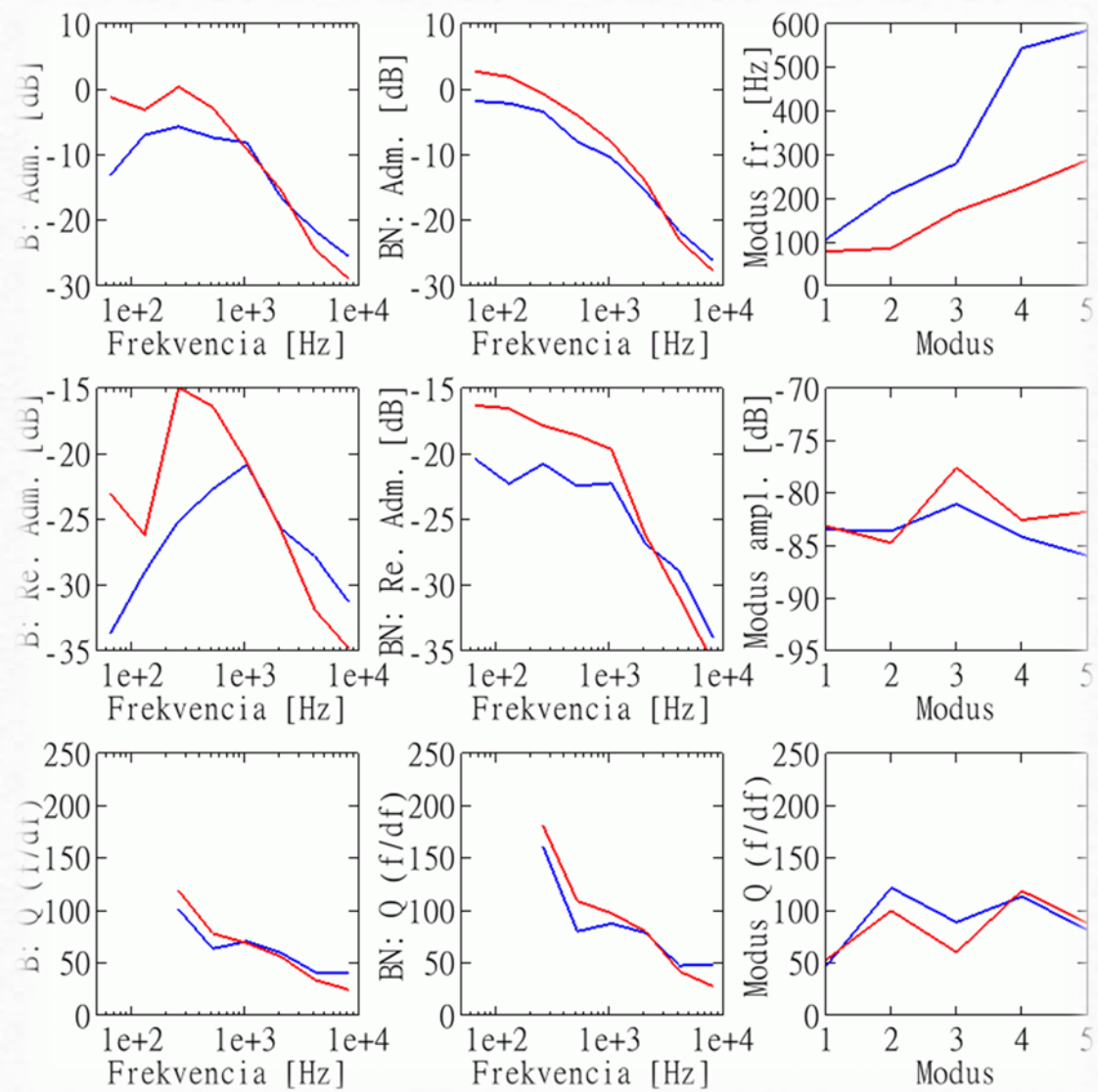







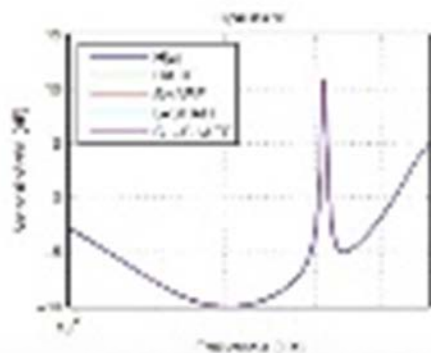
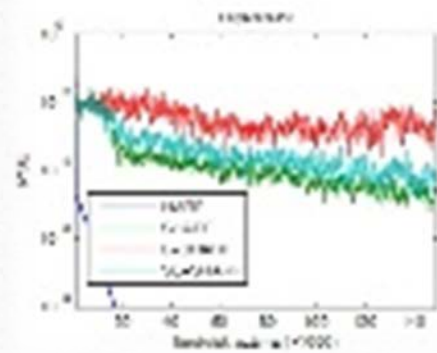
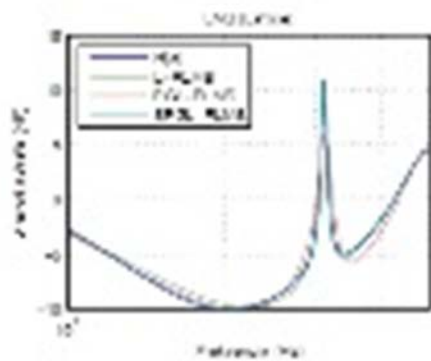
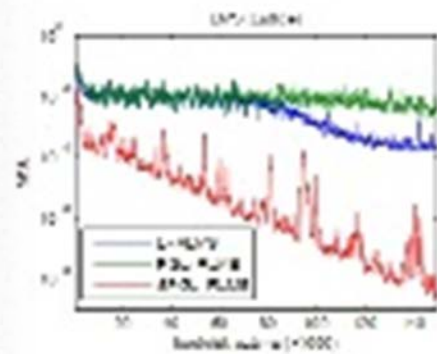
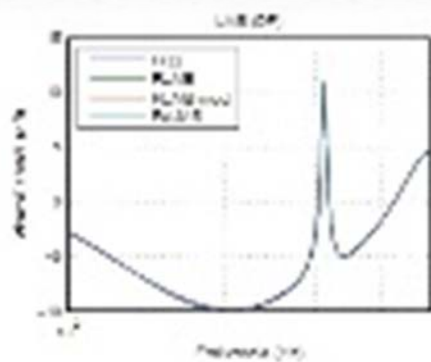
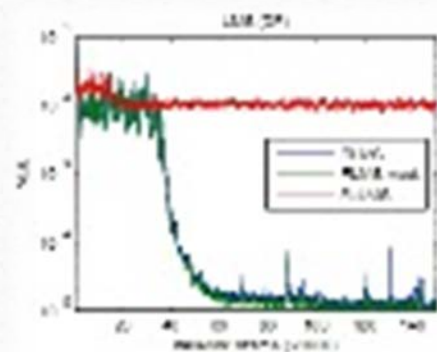







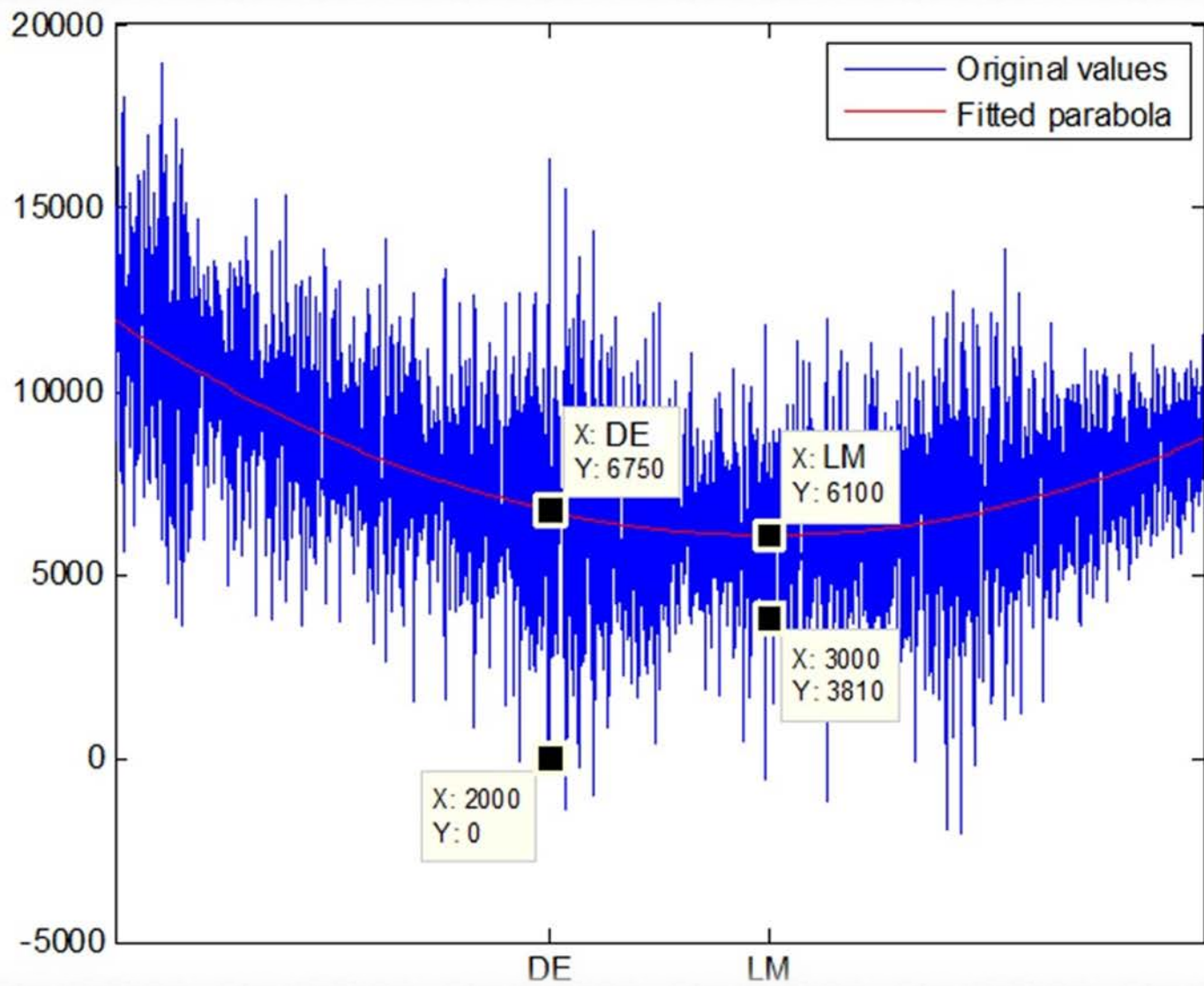



















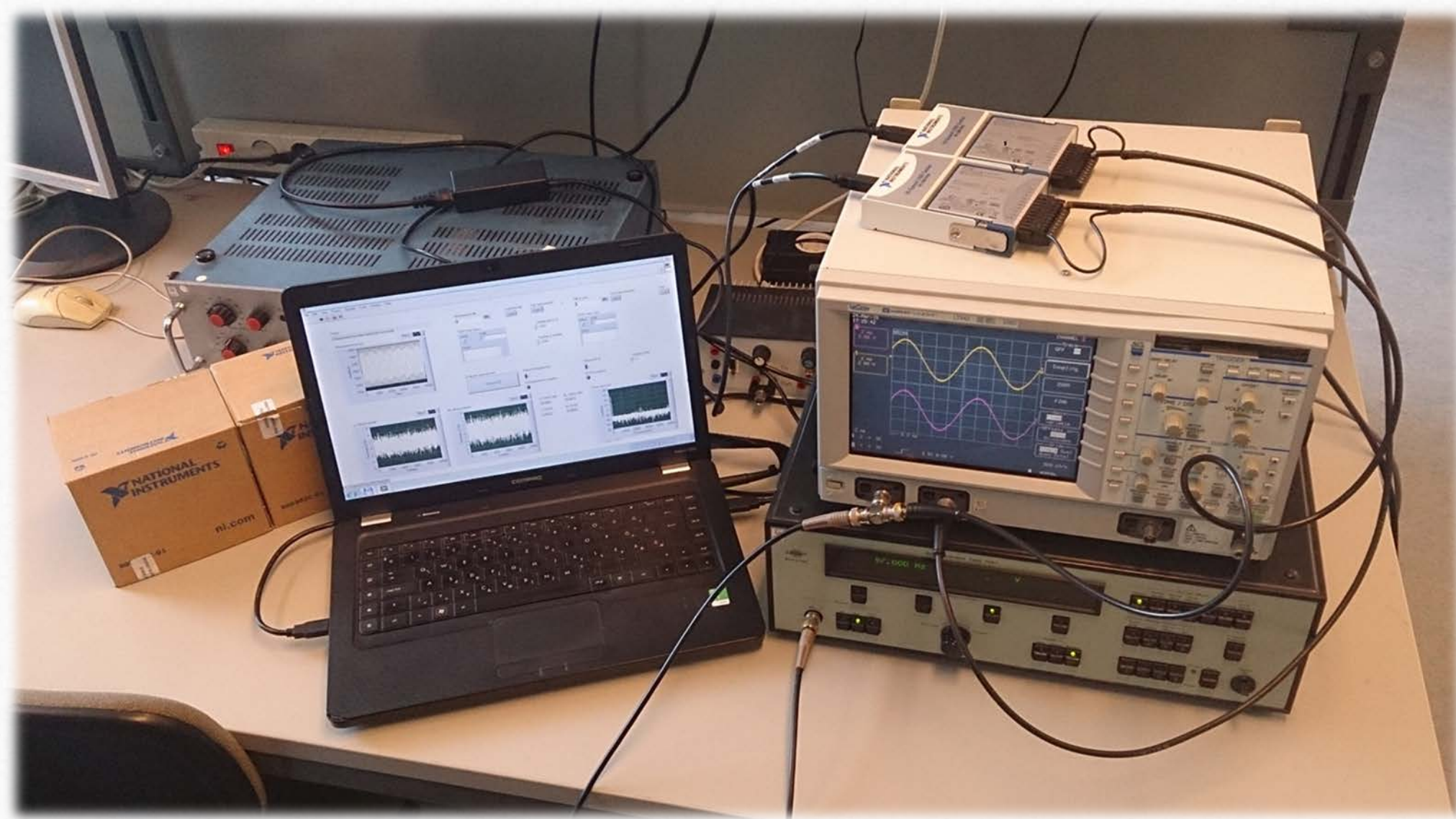











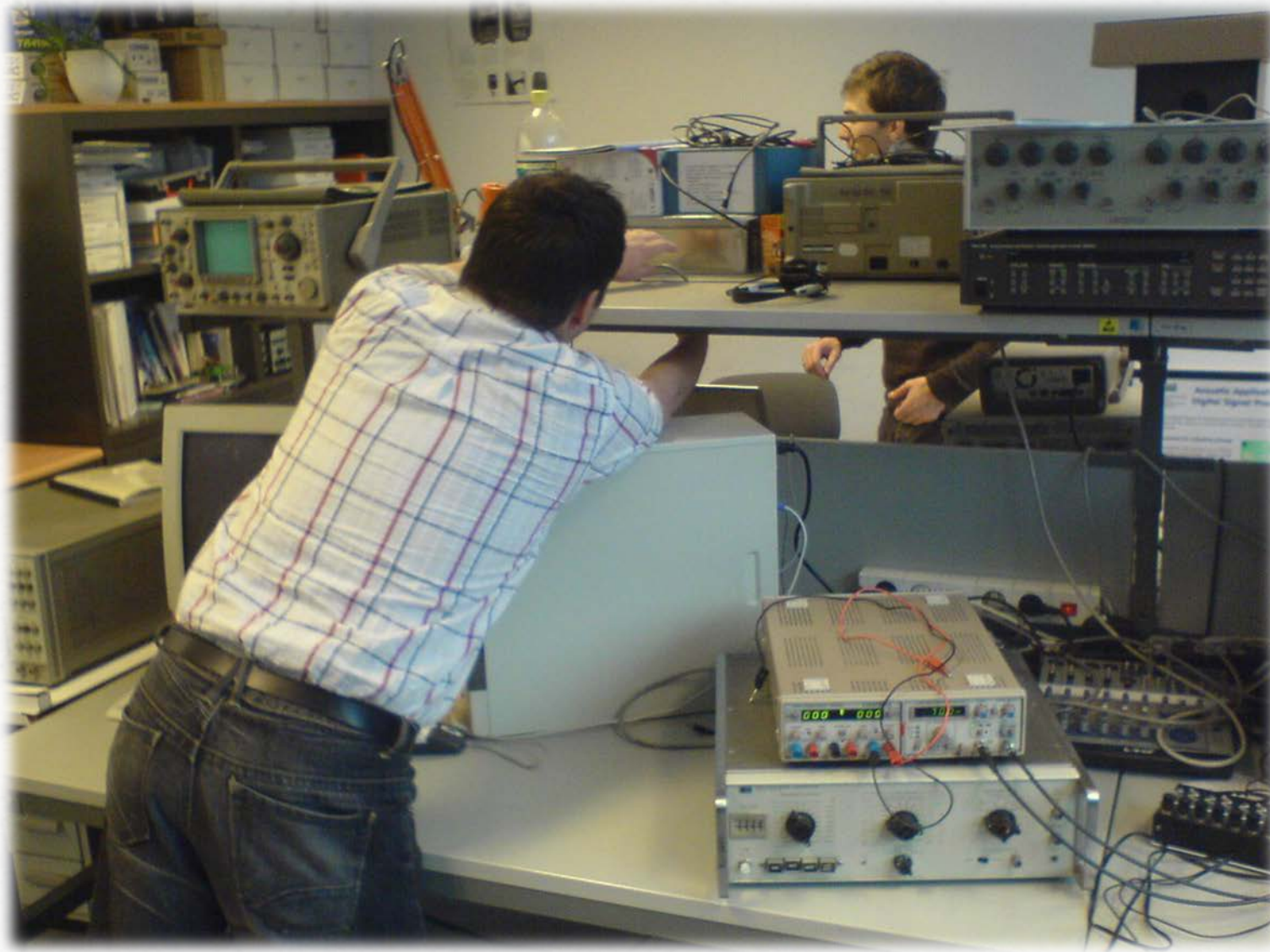























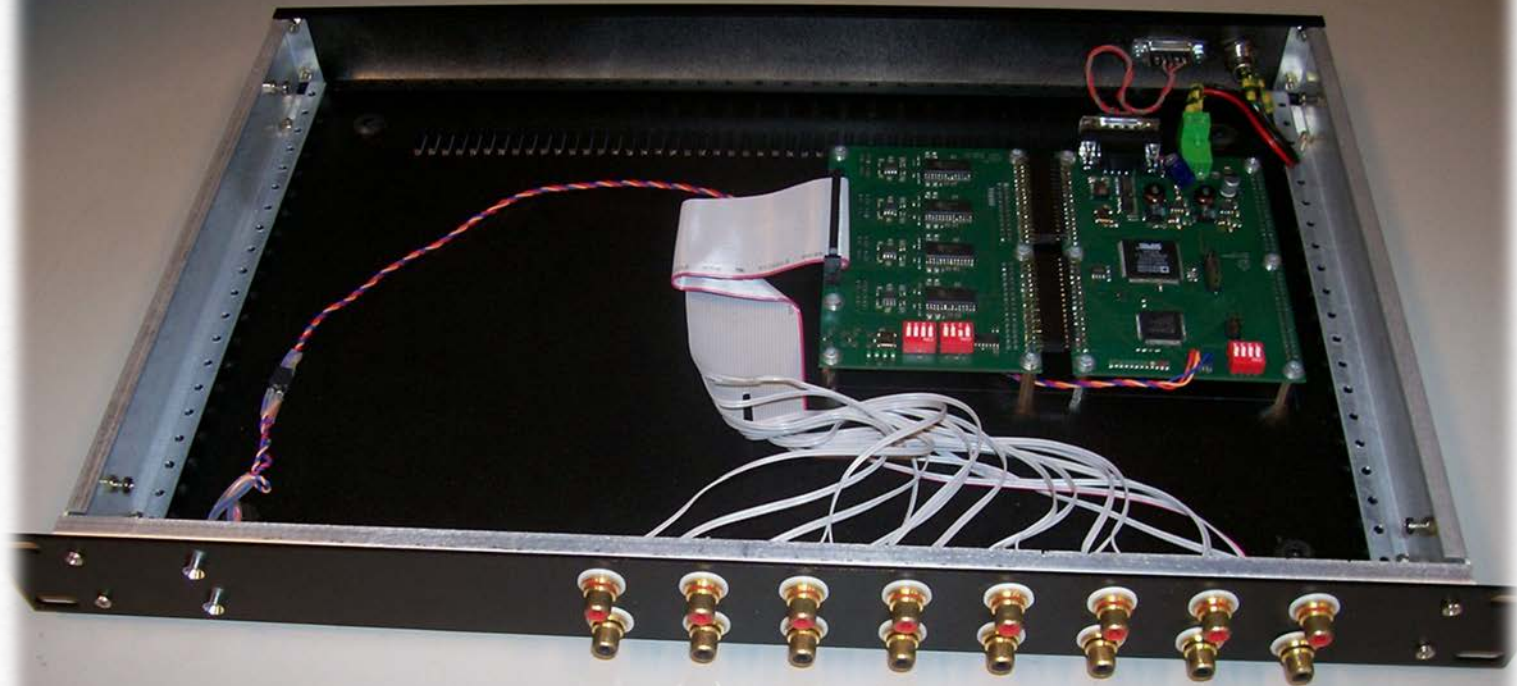



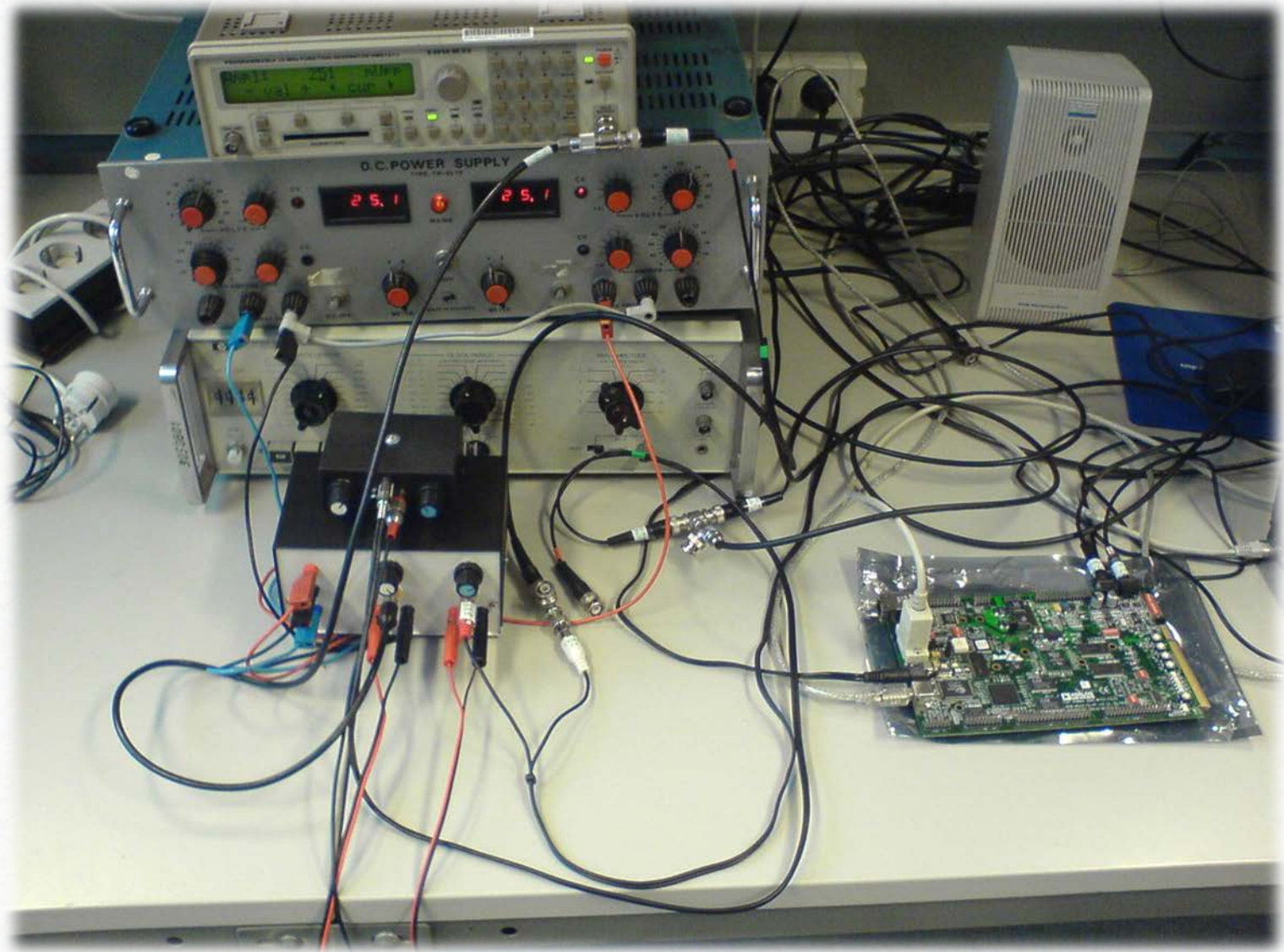



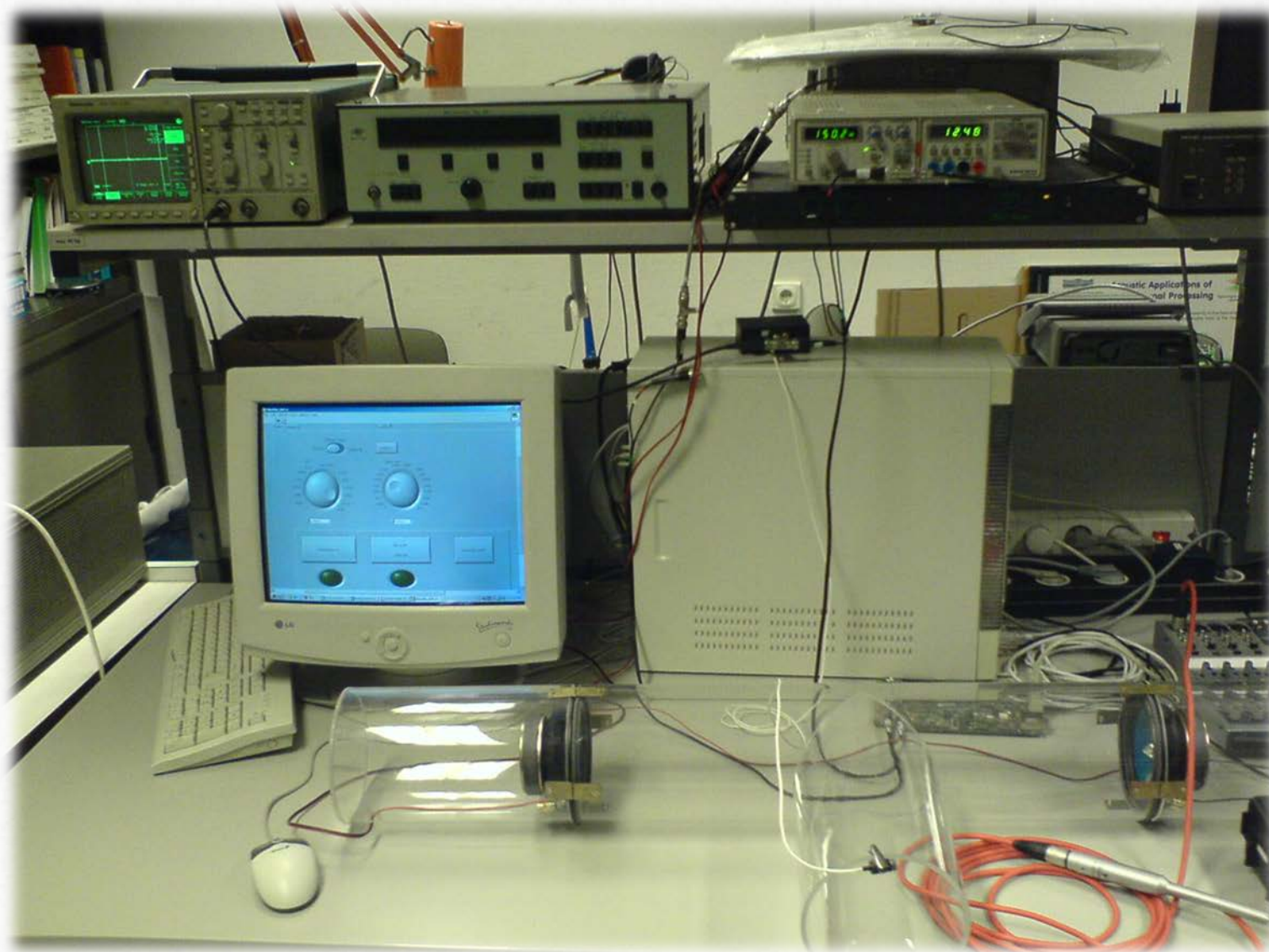











Larson Davis  
CAL150

ON

94dB

114dB



Precision Acoustic Calibrator  
1000 Hz

www.larson-davis.com



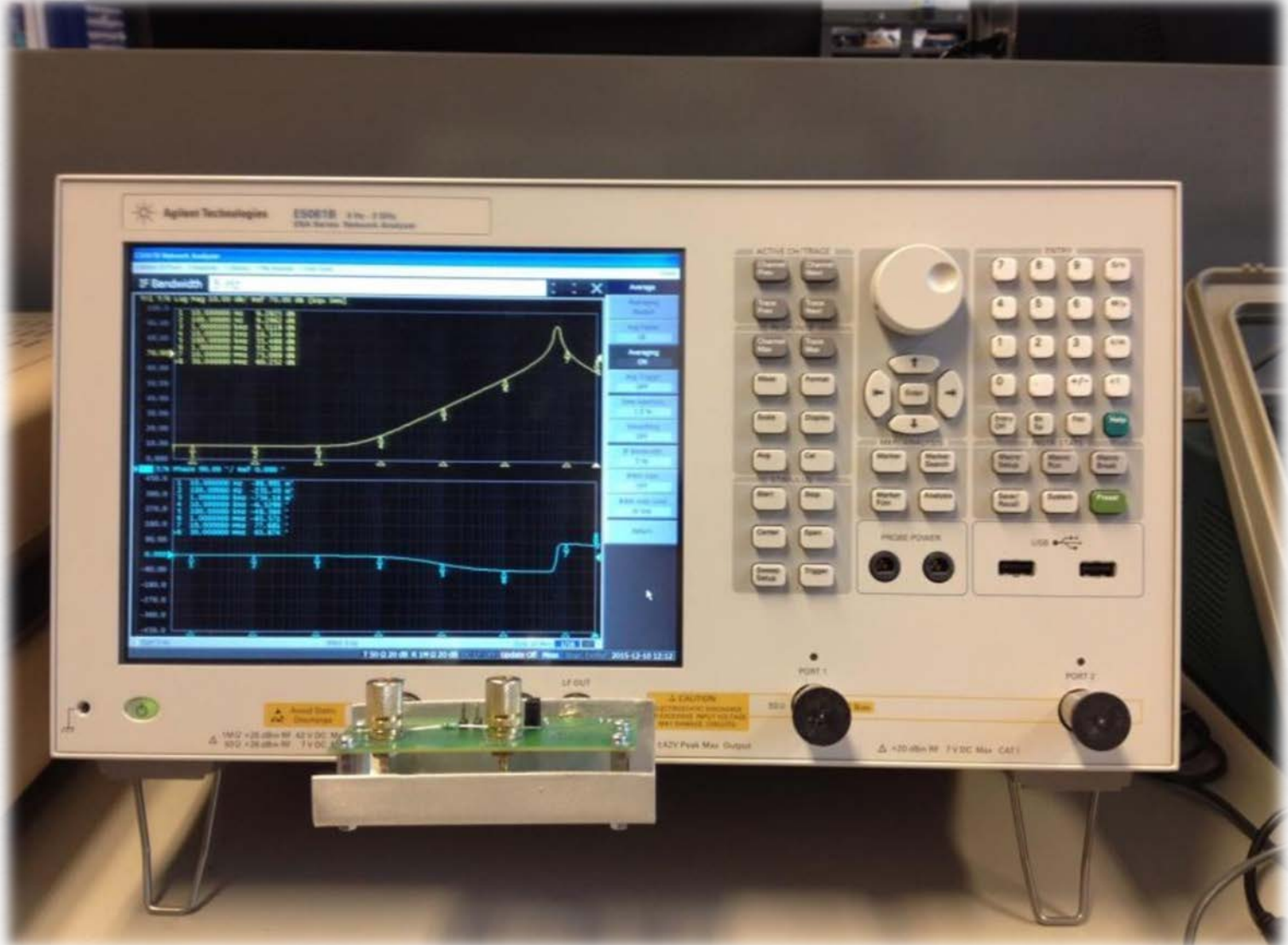



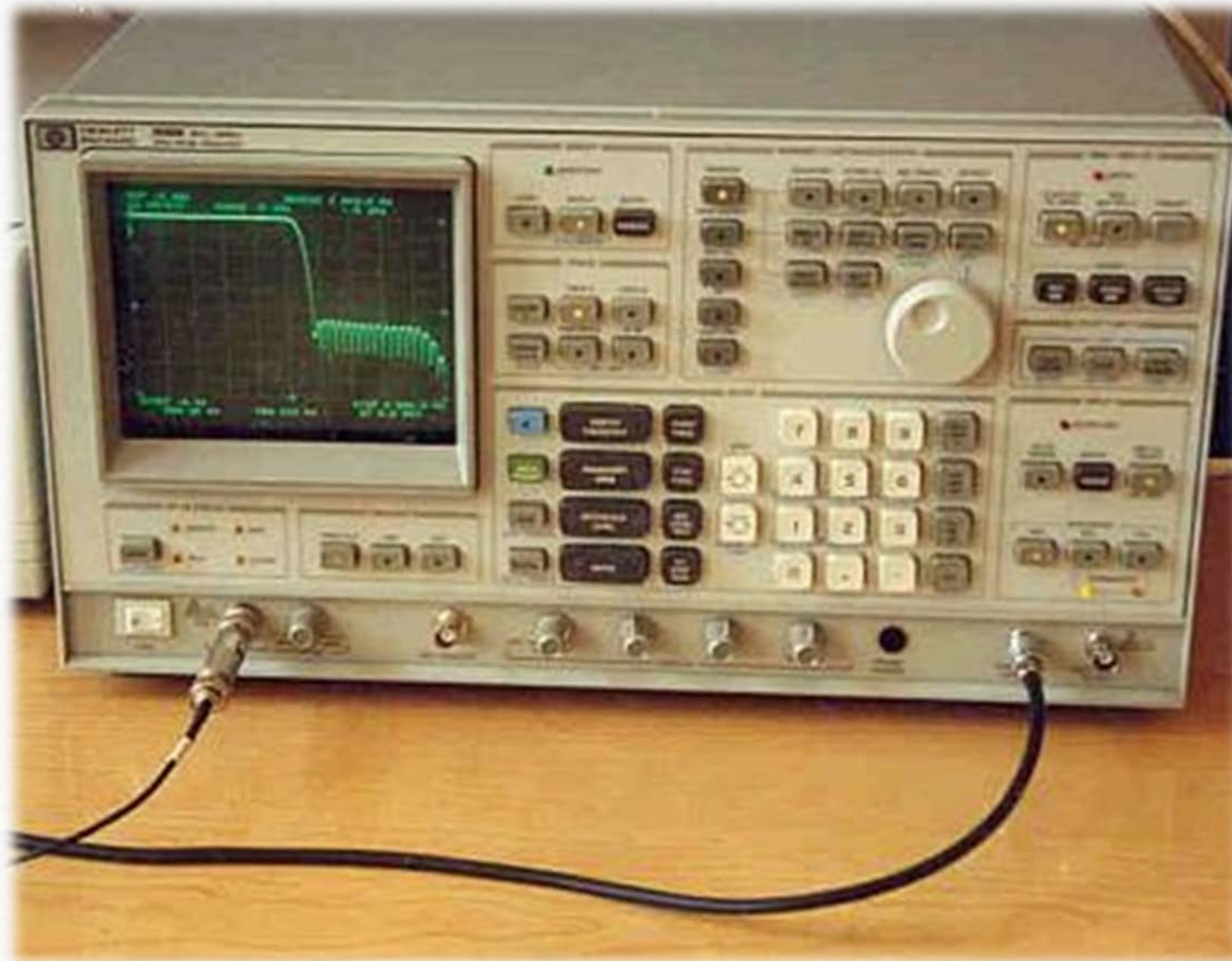























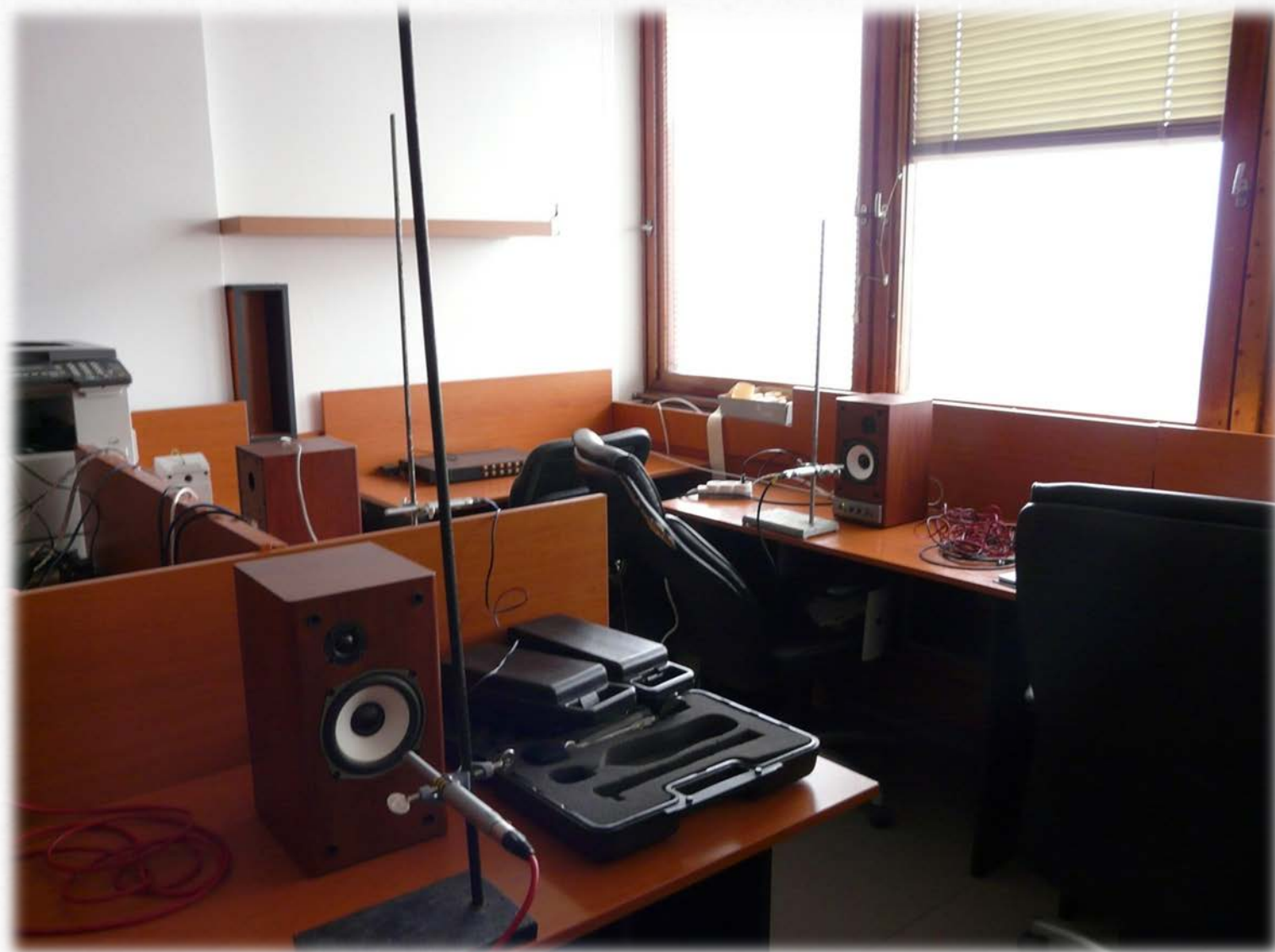







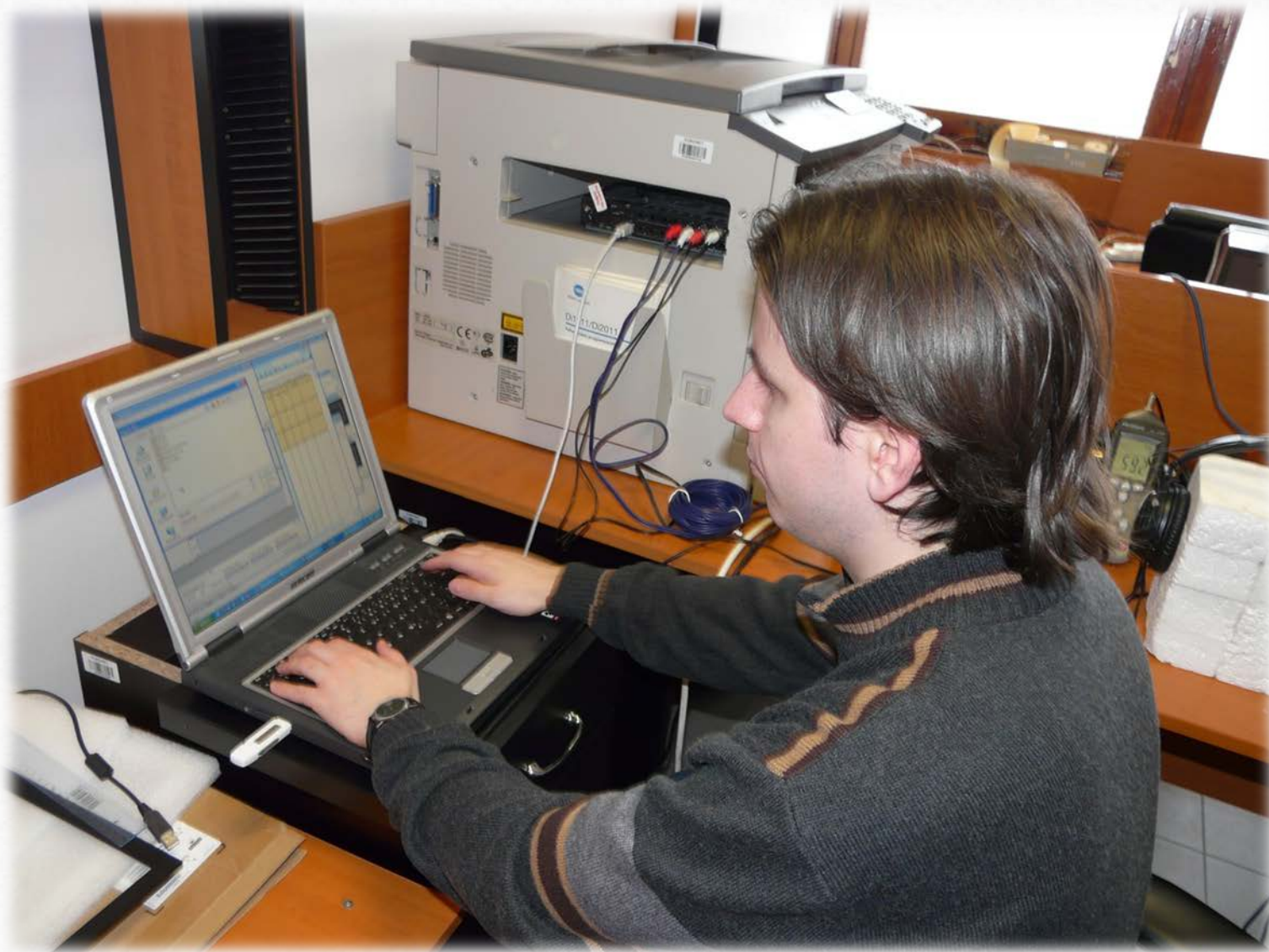















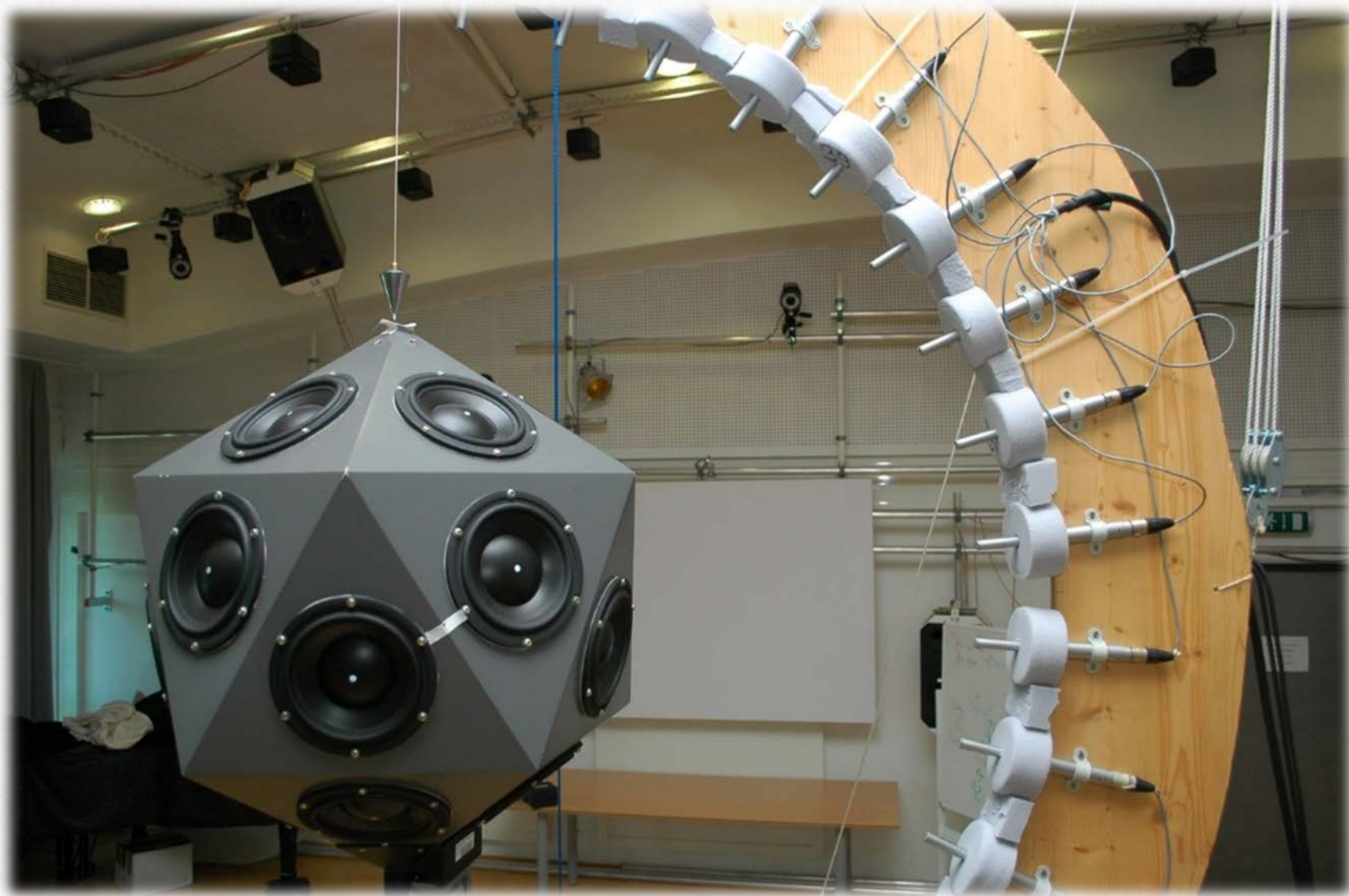









12/14/1999





20<sup>th</sup> IMEKO TC4 International Symposium  
18<sup>th</sup> IWADC International Workshop on ADC and DAC Modeling and Testing  
September 15-17, 2014  
Benevento, Italy

# ADC Testing in Standard and Nonstandard Ways Using a Unified Framework

Tamás Viroztek, István Kollár

Budapest University of Technology and Economics  
Department of Measurement and Information Systems















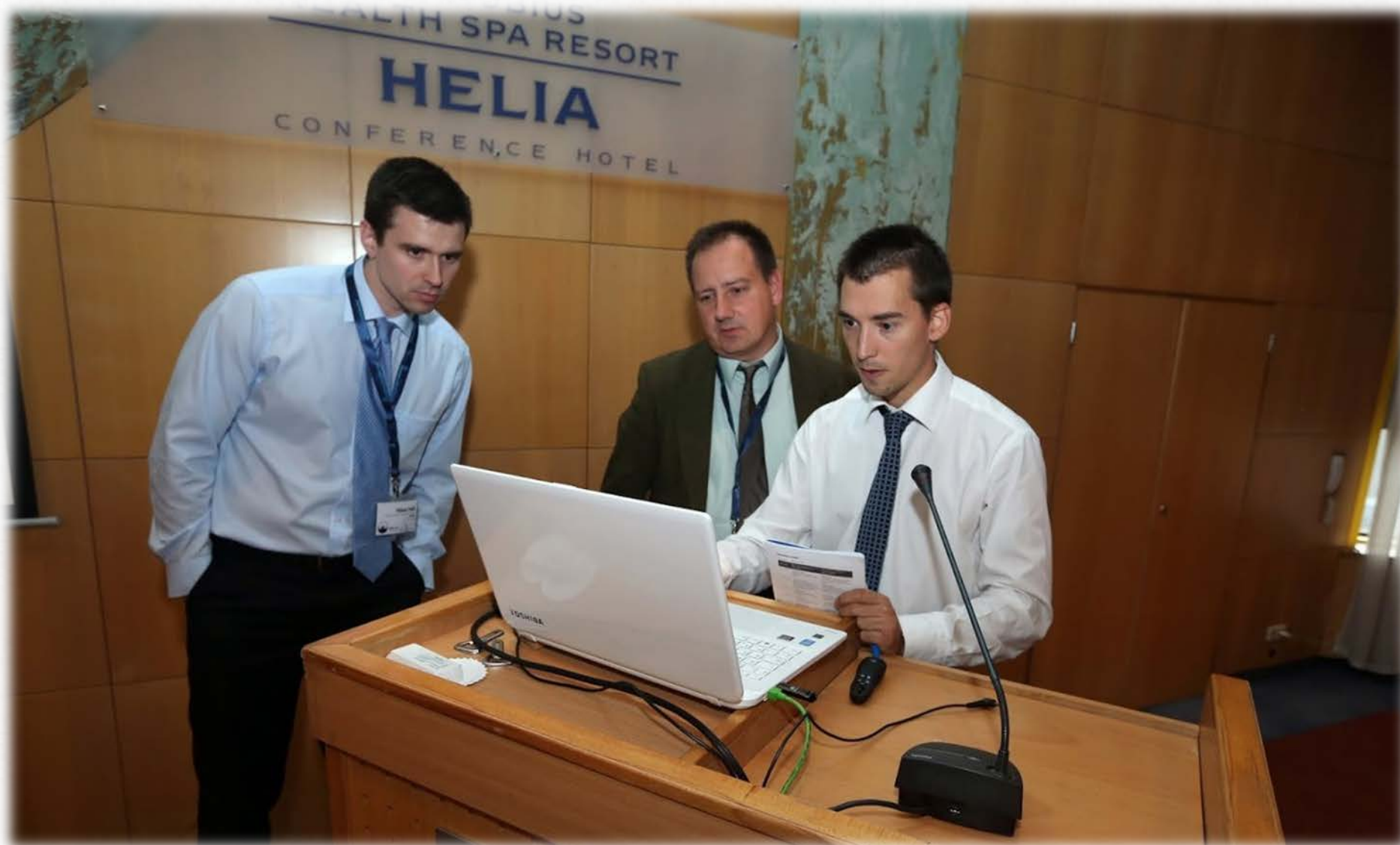















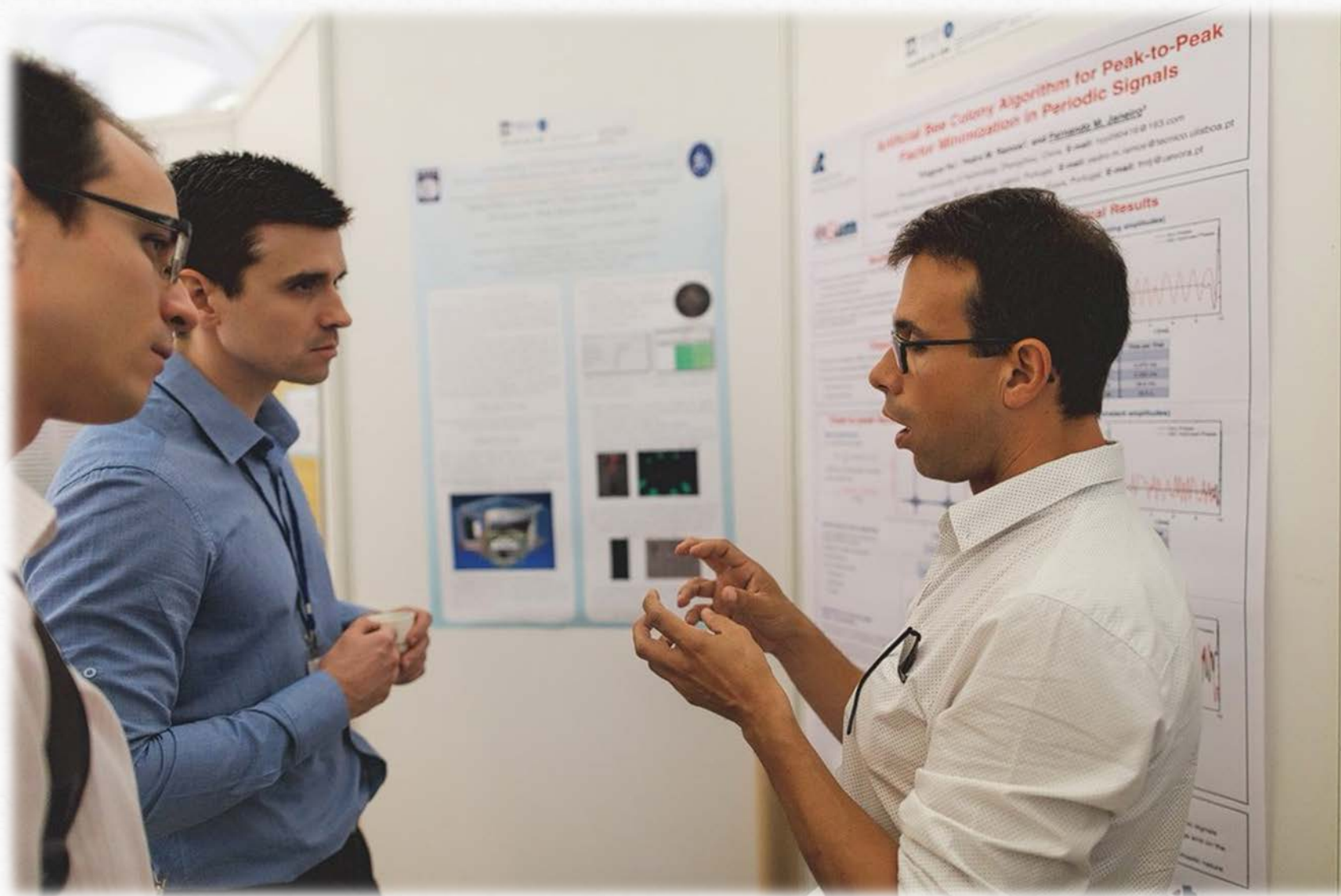

# Additional Box-Coxity Algorithm for Peak-to-Peak Traffic Minimization in Periodic Signals

Author: Rui M. Santos, and Francisco M. Janeiro  
E-mail: rui@ua.pt, f.janeiro@ua.pt

## Final Results

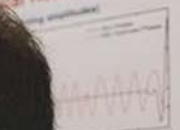







A tervezett inverz szűrő amplitúdójellemzője

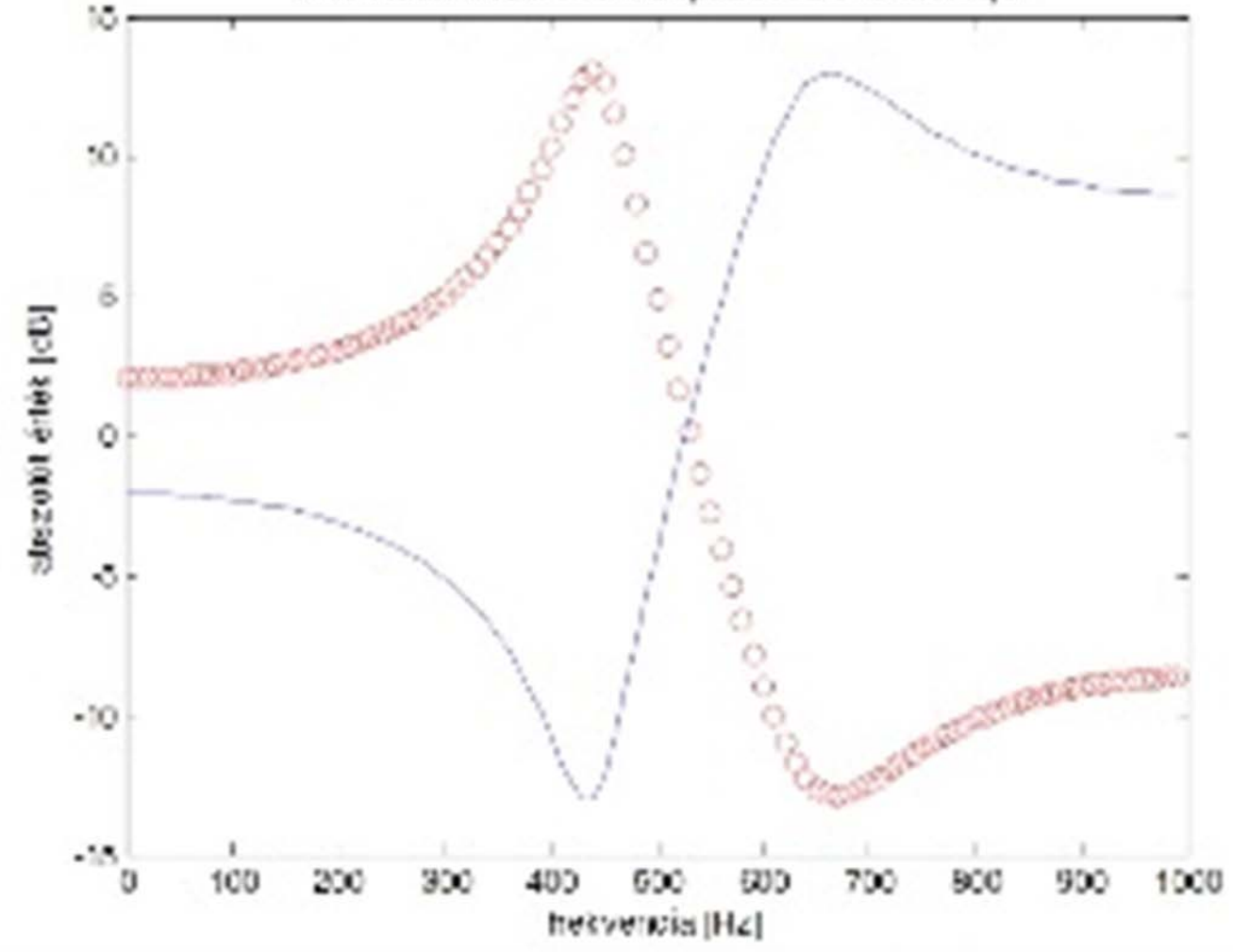



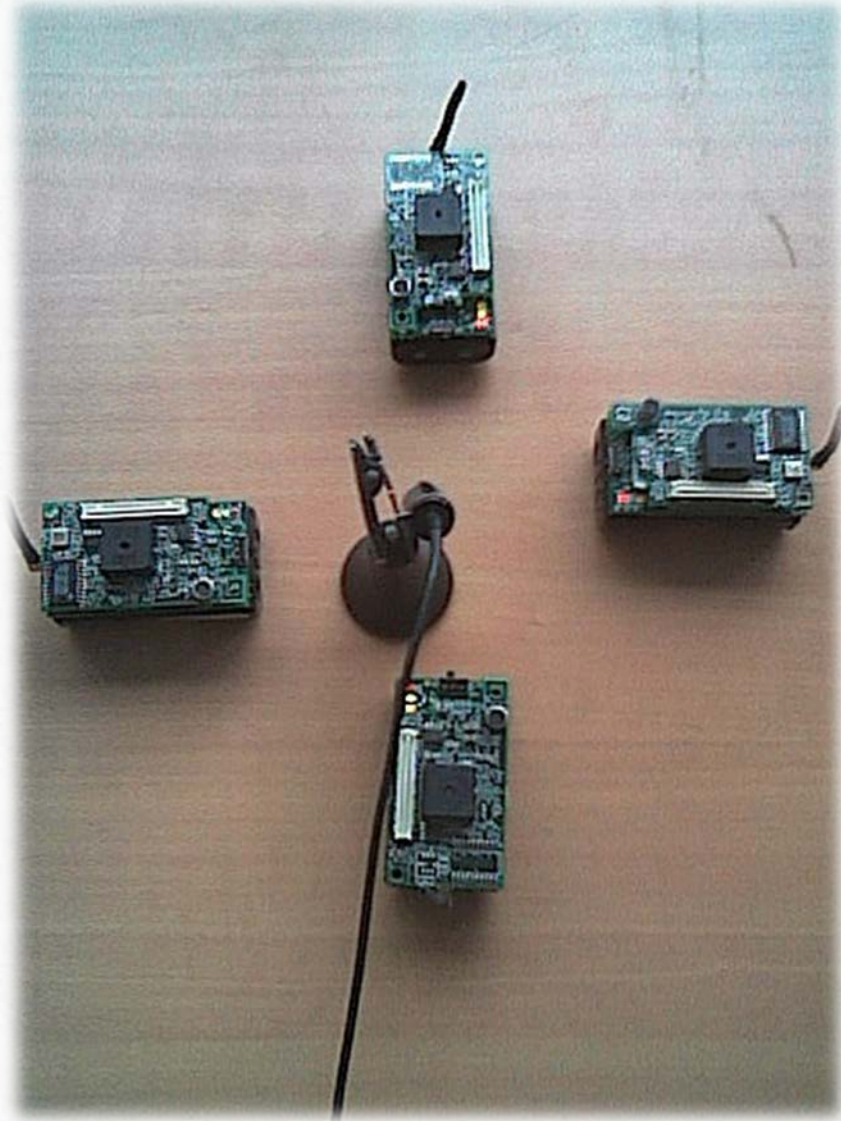











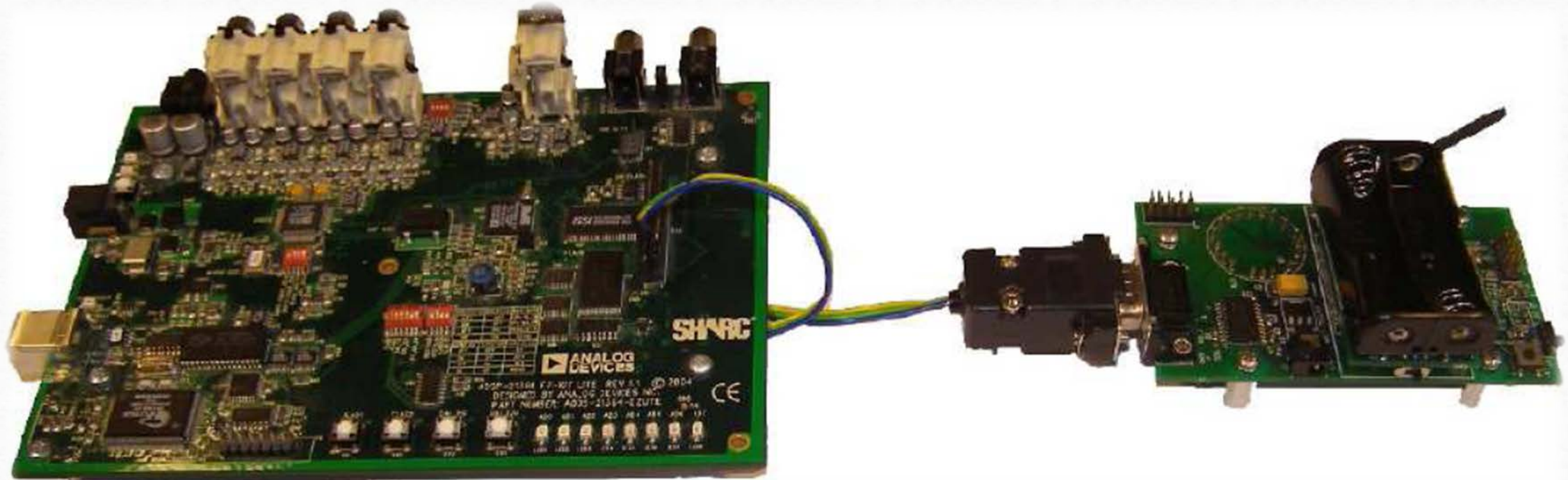

ADSP-21364 F7-R07 LITE REV 5.3 © 2004  
DESIGNED BY ANALOG DEVICES INC.  
PART NUMBER: ADSP-21364-EZUTL

SHARC

ANALOG DEVICES





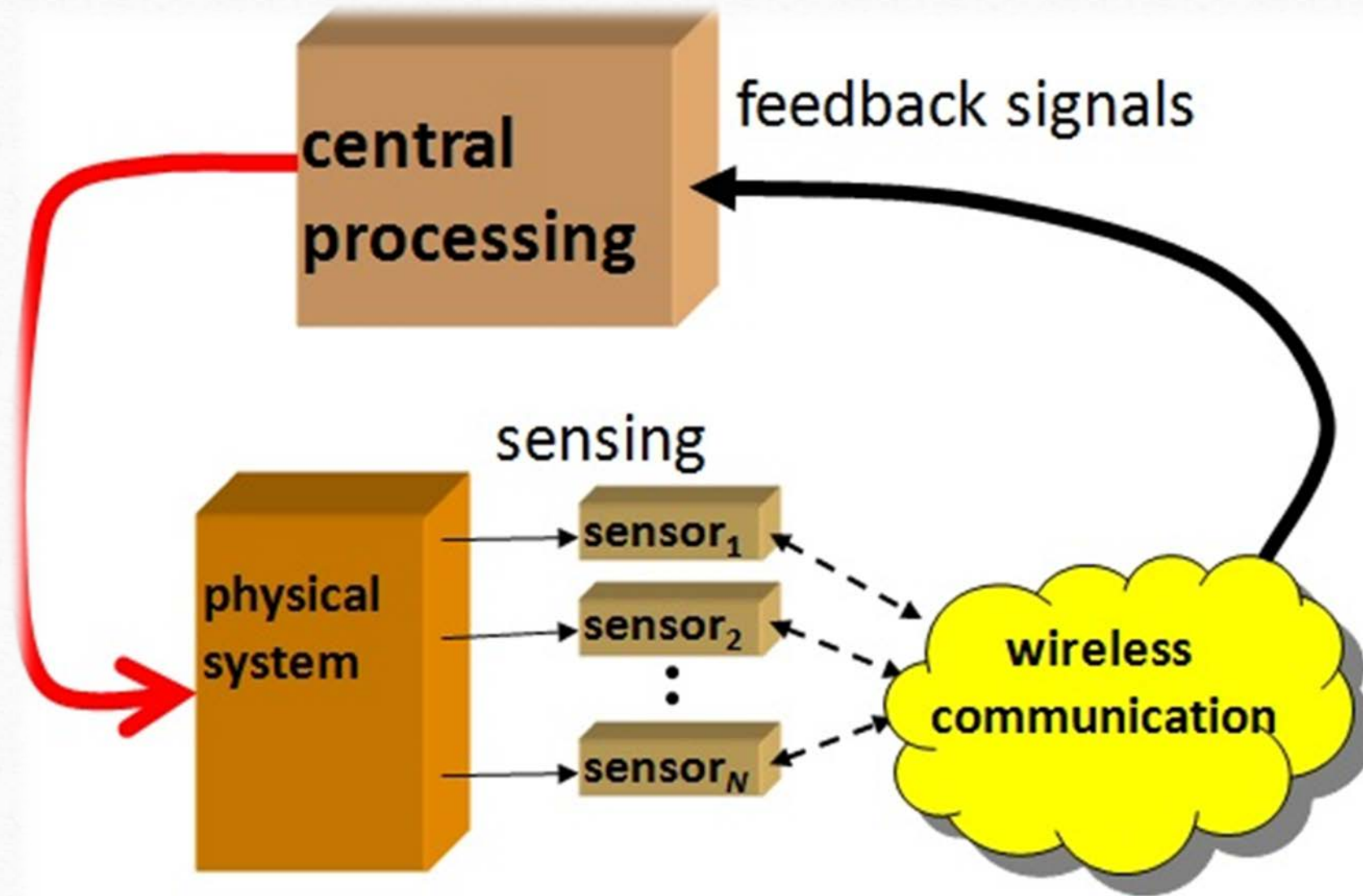



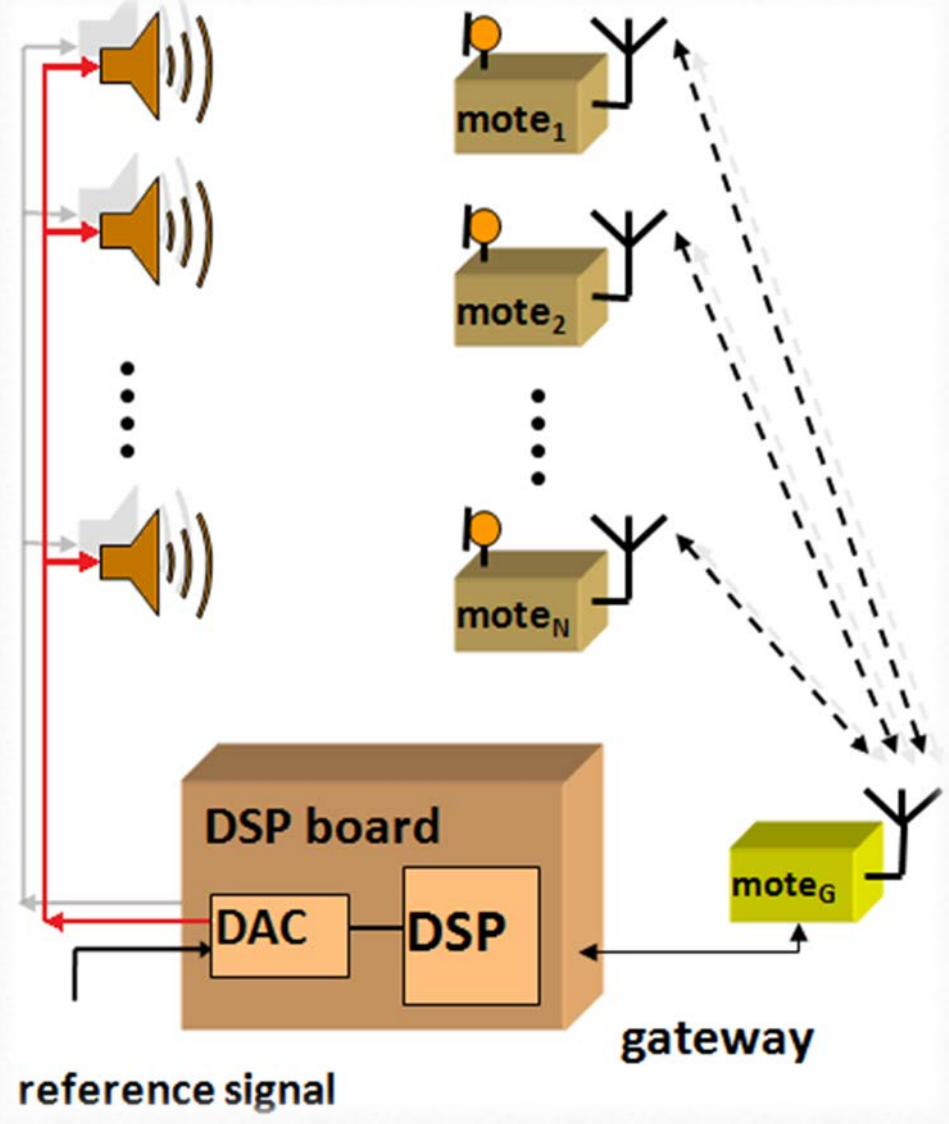



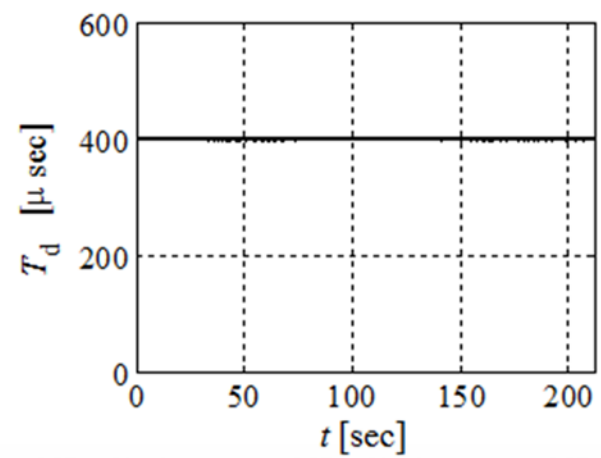
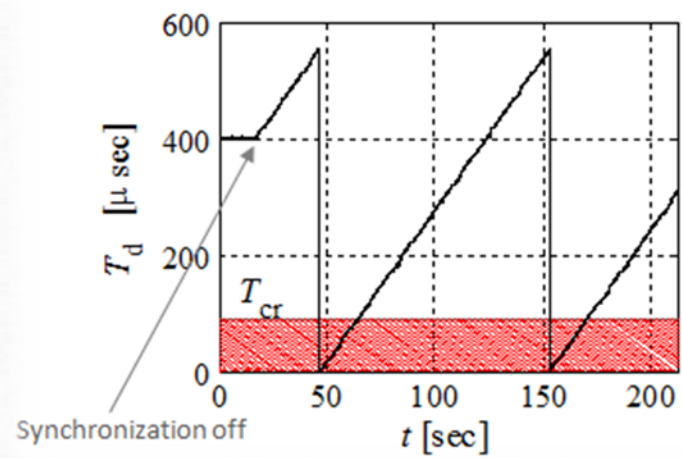
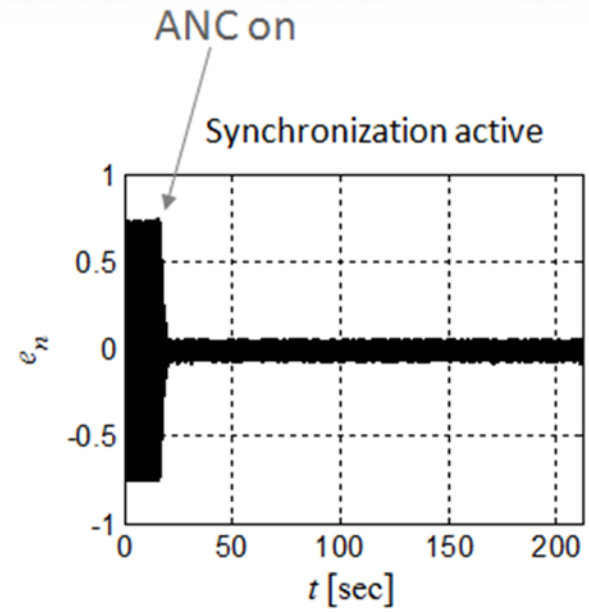
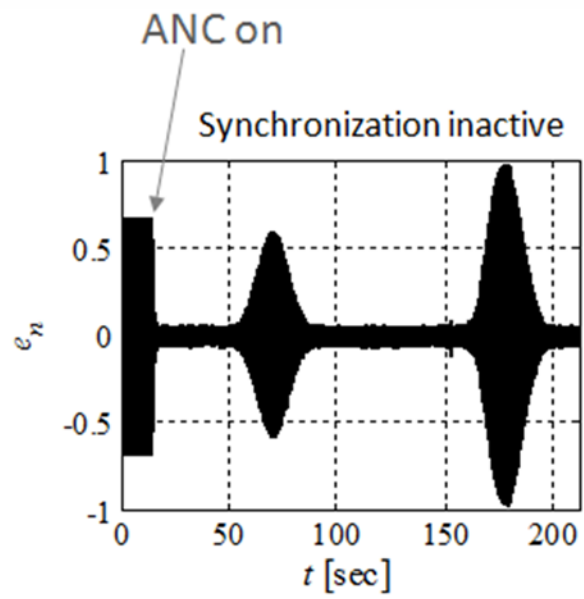



basic algorithm

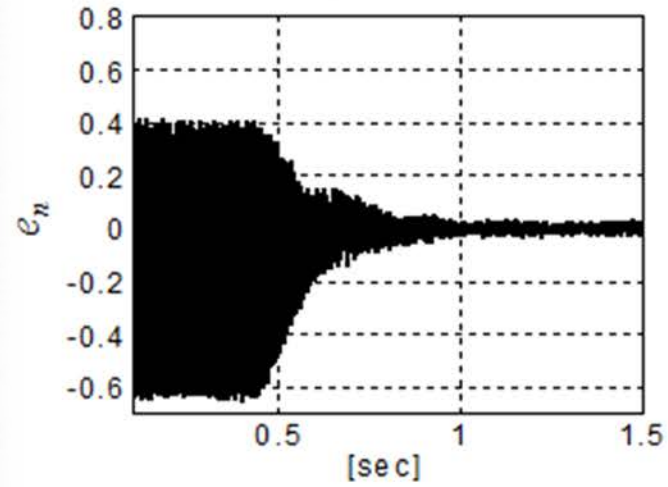

sign-error algorithm

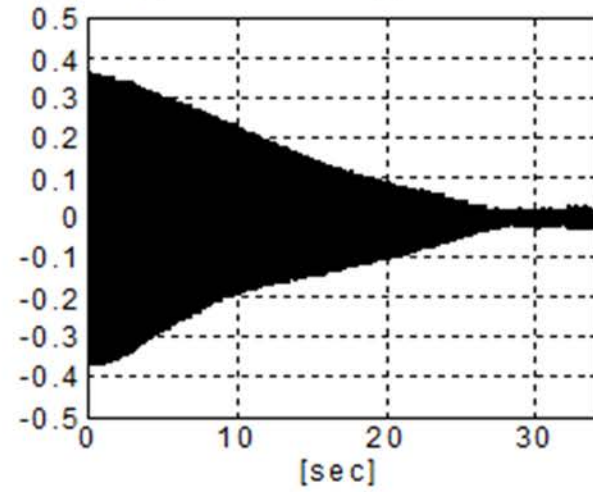

improved  
sign-error algorithm

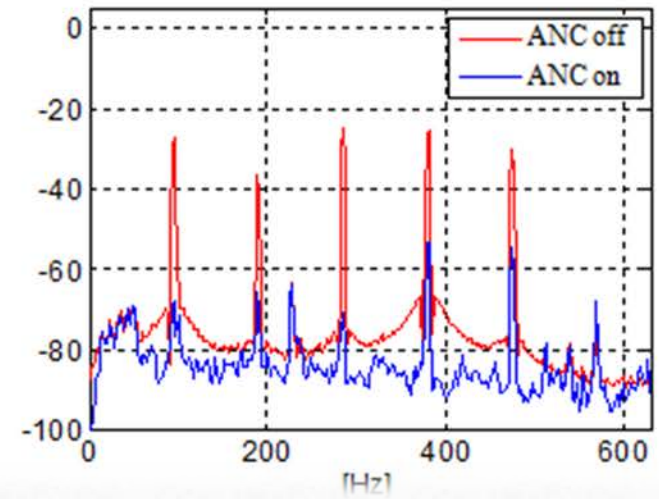
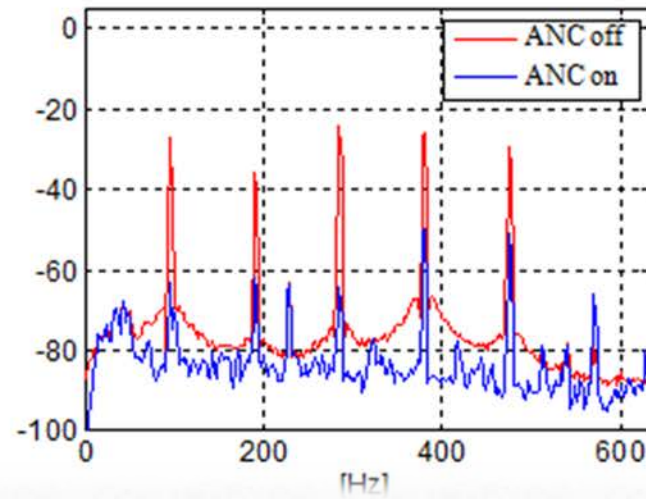
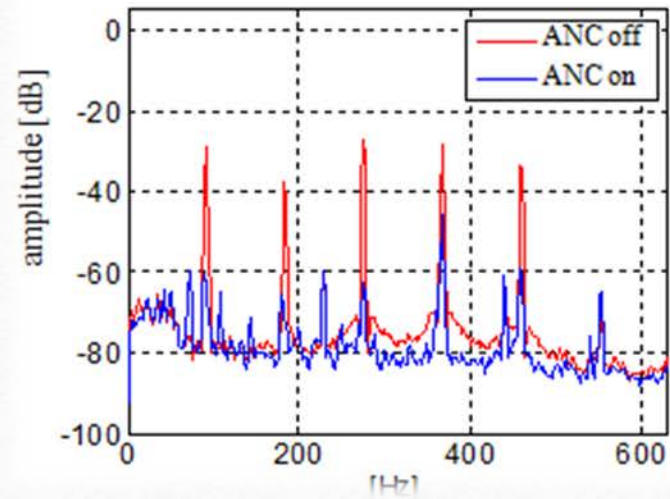
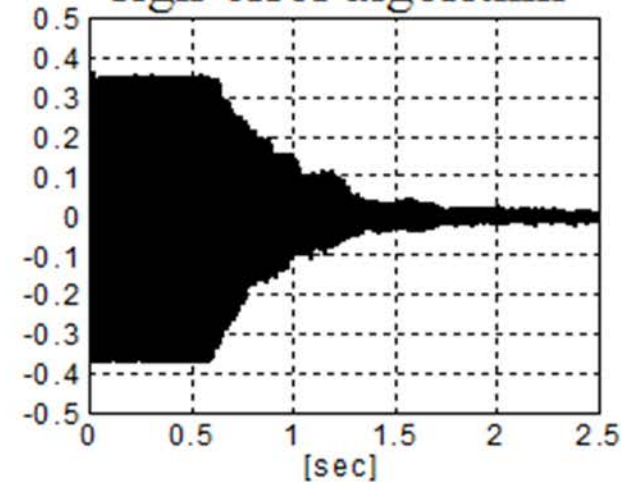









### Berkeley micaz mote

- ZigBee radio 2.4 GHz
- 8 bit microcontroller
- sensor board with microphone







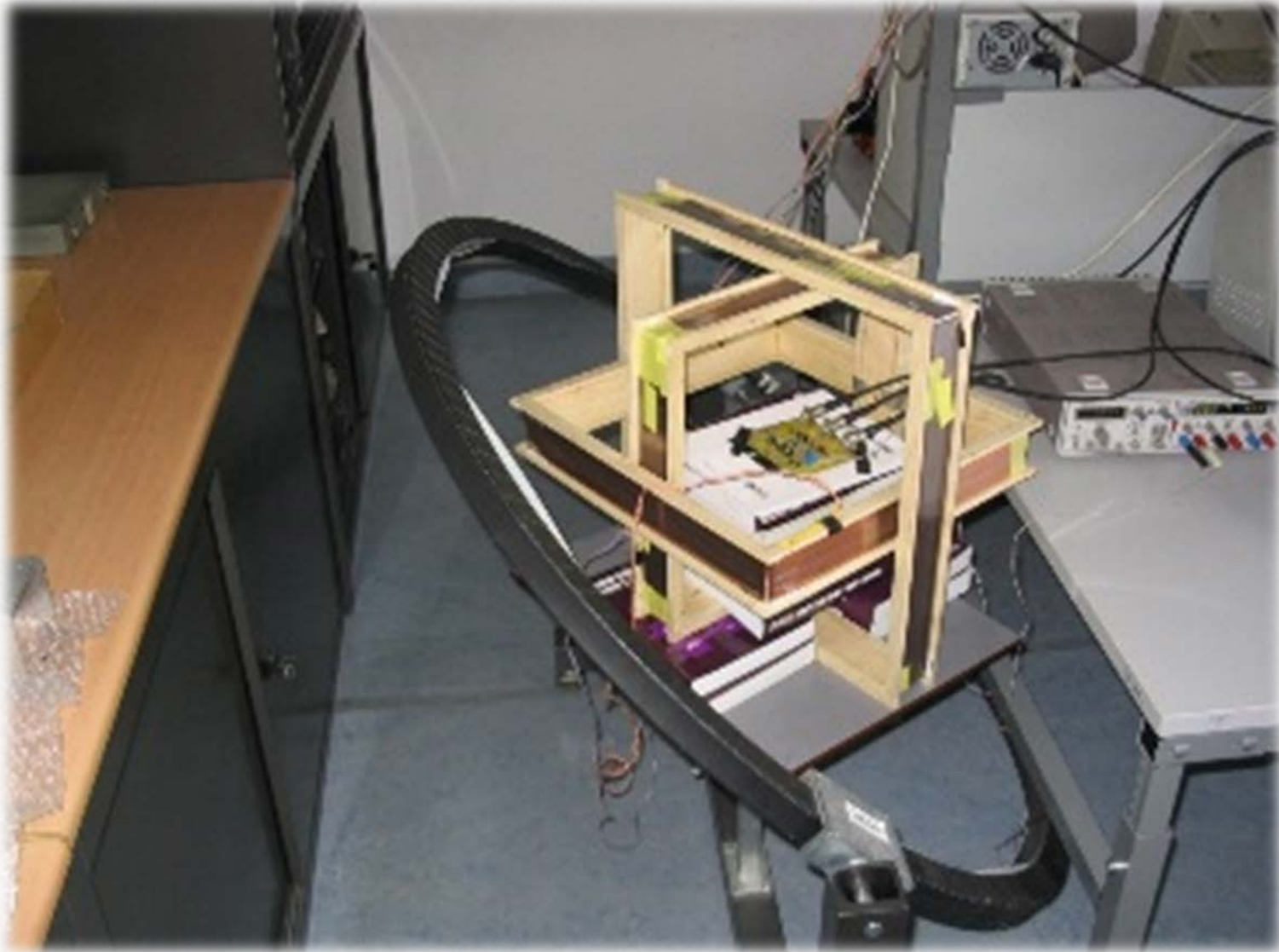



8. A lineáris hálózatunk amplitudó karakterisztikája sokféleképpen mérhető. Az egyik ~~ily~~ mérési módszer, hogy megfogjuk a hálózatunkat, esetleg a modelljét, és egy képzett villamosmérnöknek, egy szakembernek, ~~adatok~~ átadjuk és rábisszálunk a mérés elvégzésére.



↓  
 folyamat ábra:

↑ pont: a képzett vill-mérnök

↓  
 rész  
 sőr, dízettség  
 stb stb

↑  
 megmért  
 amplitudó karakterisztika



















Lévéstechnika és Információs Rendszerek

Tanszék

[www.mit.bm](http://www.mit.bm)

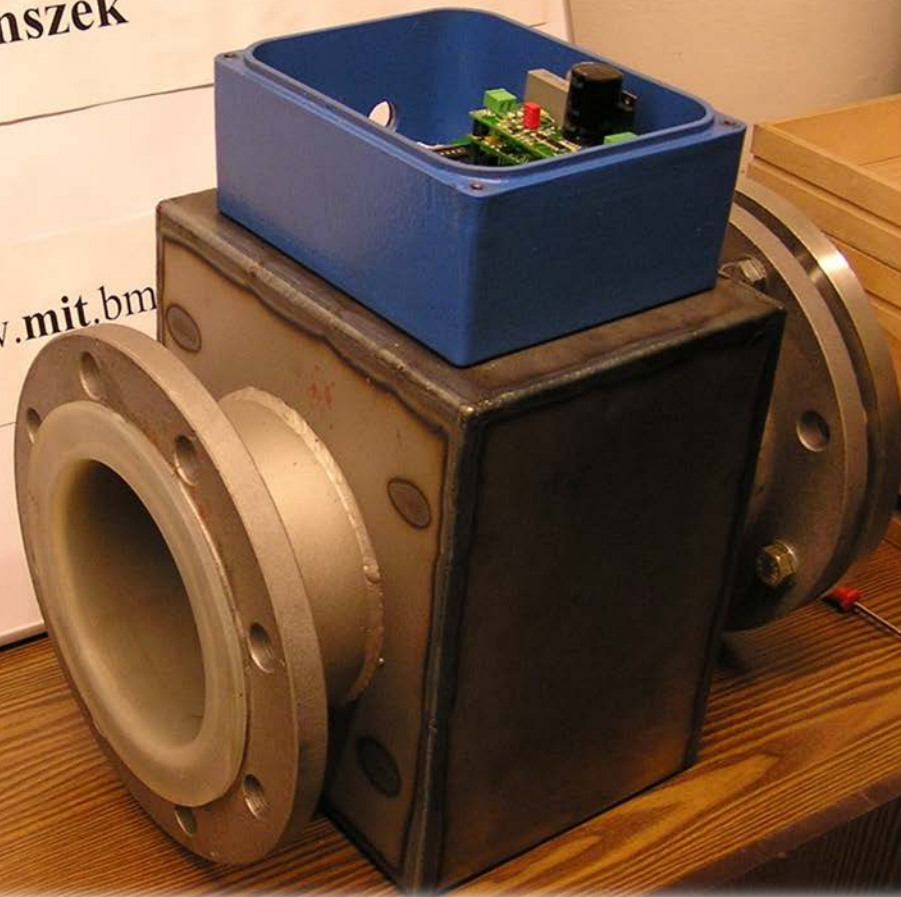



















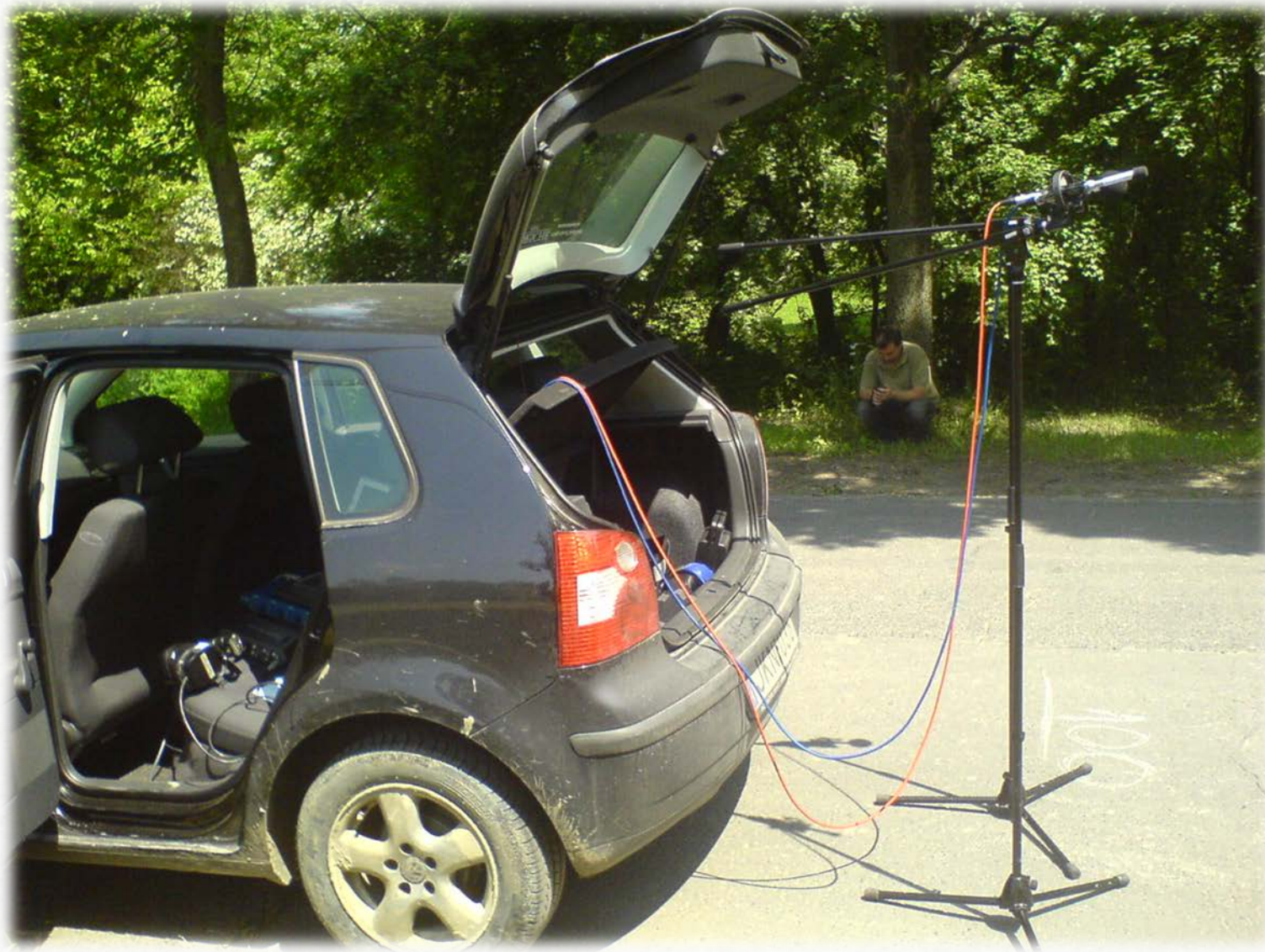







































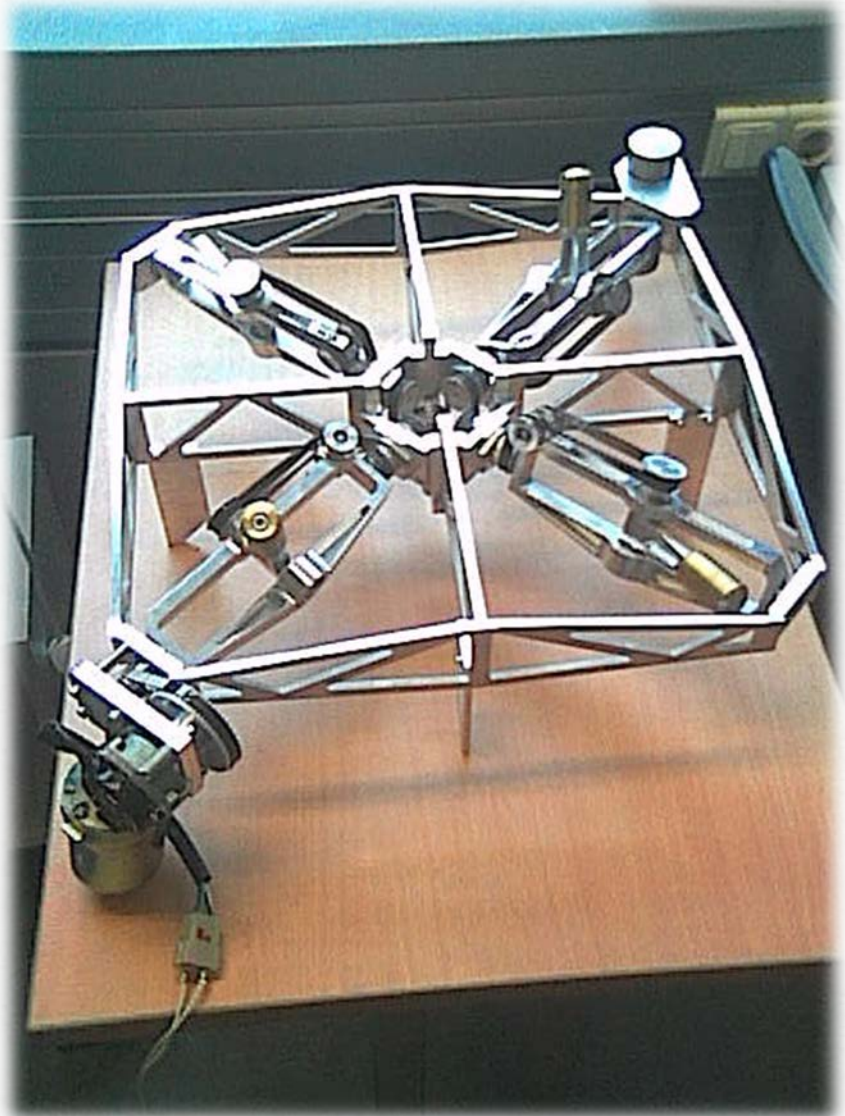



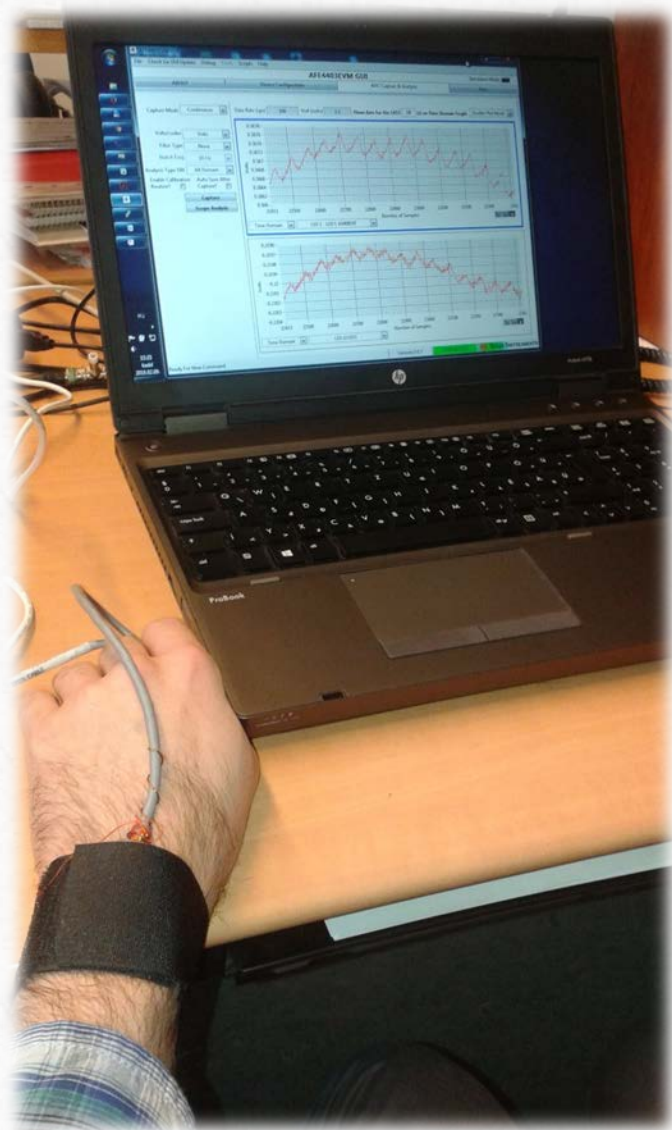



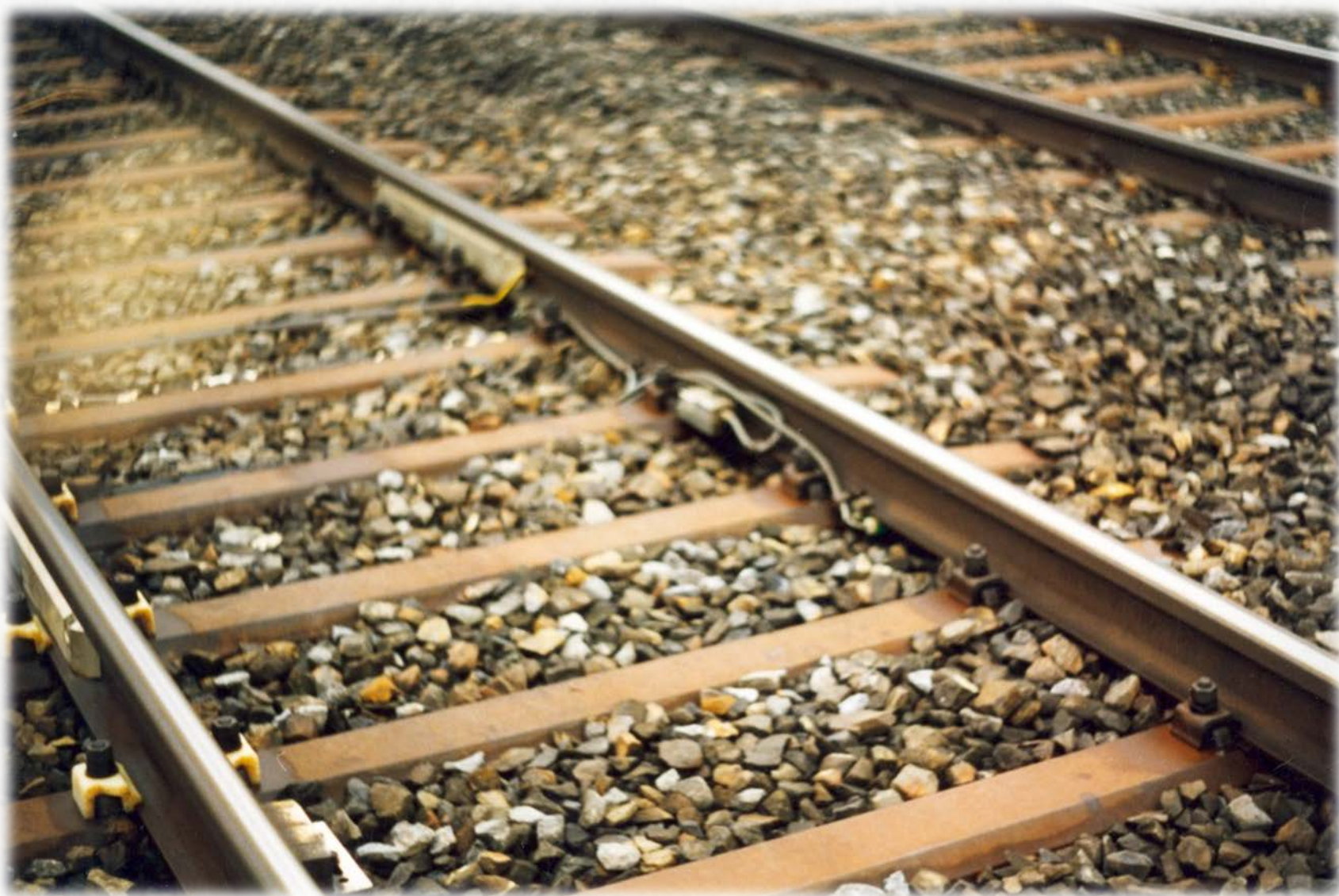







RF Antenna  
@ GHz

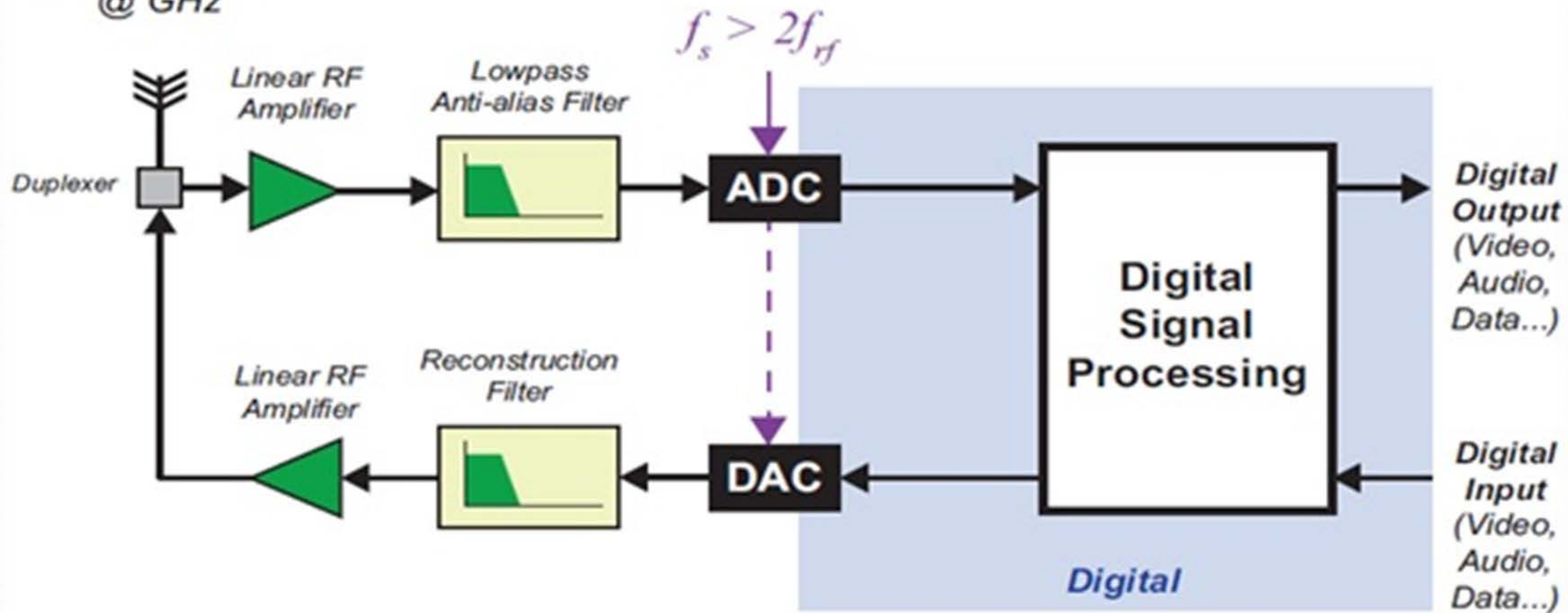



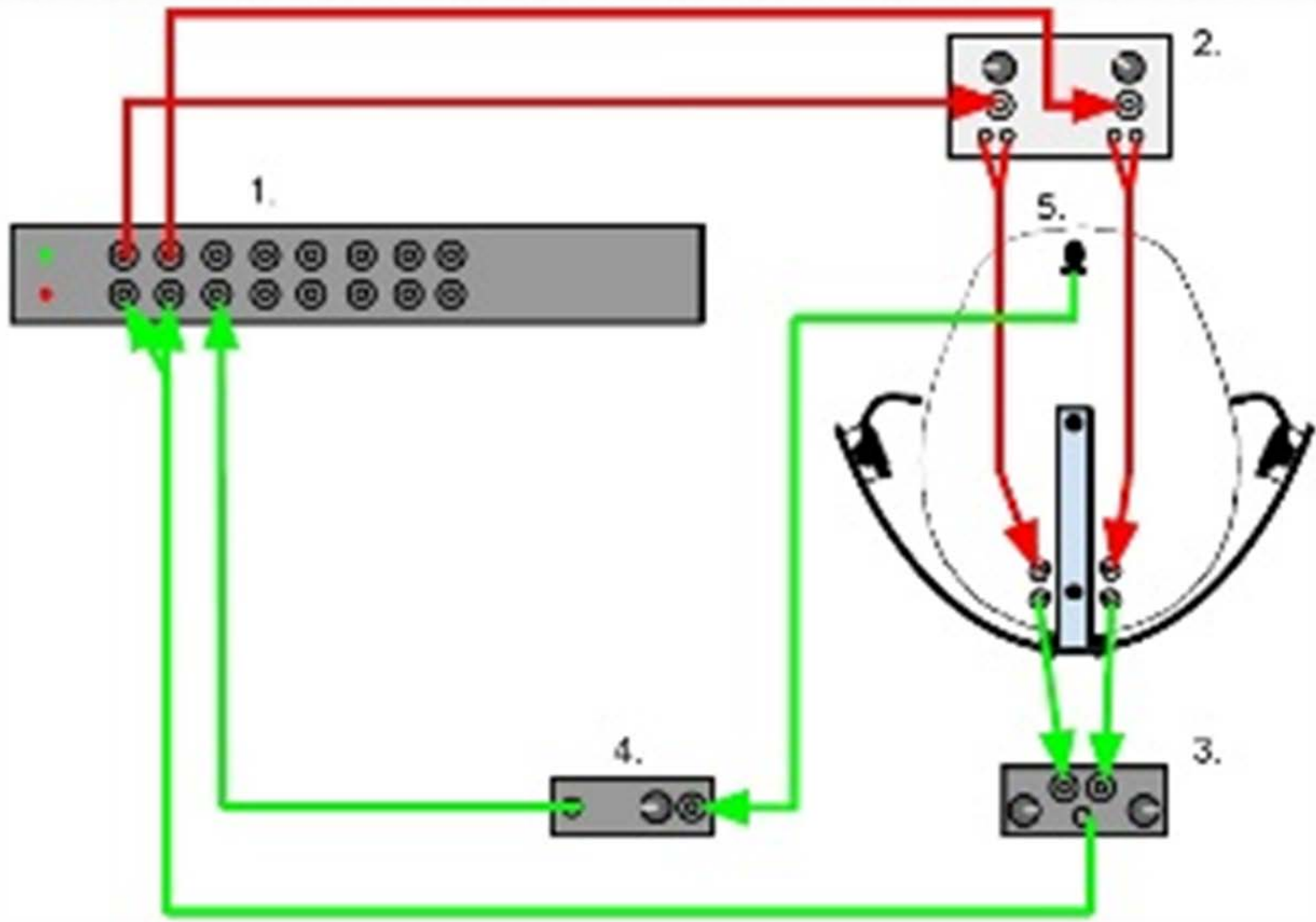



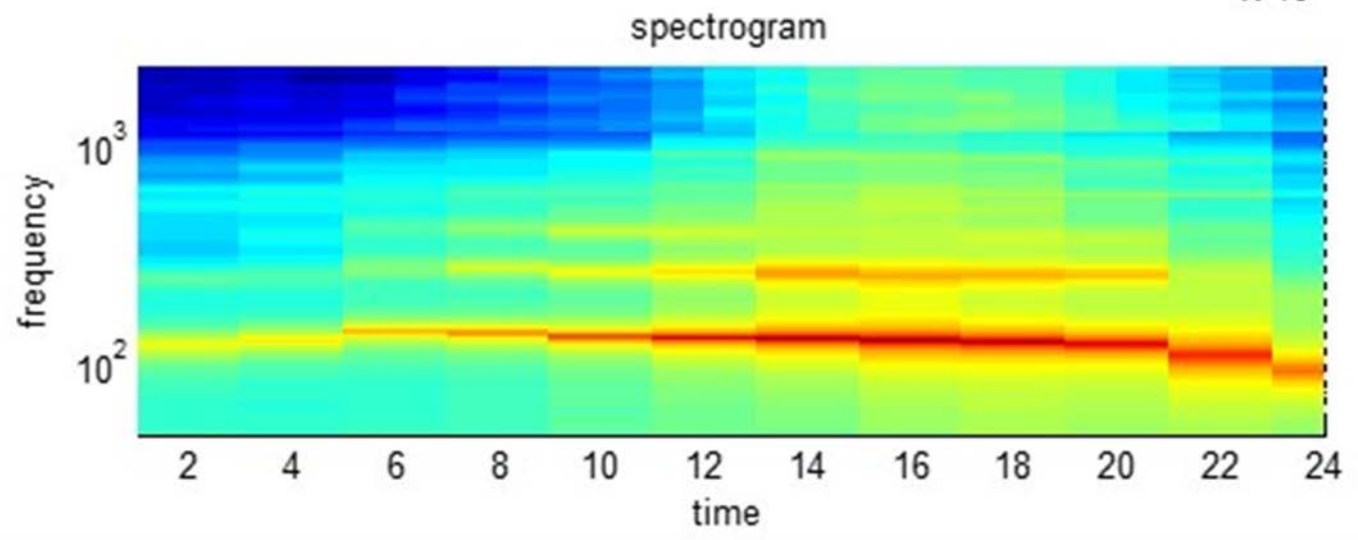
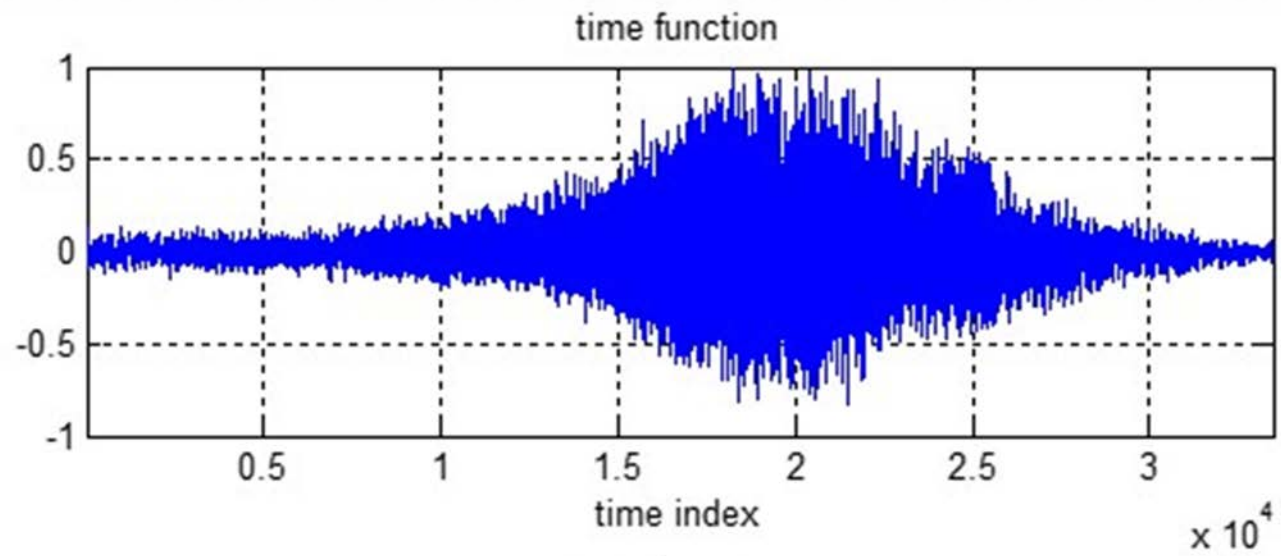



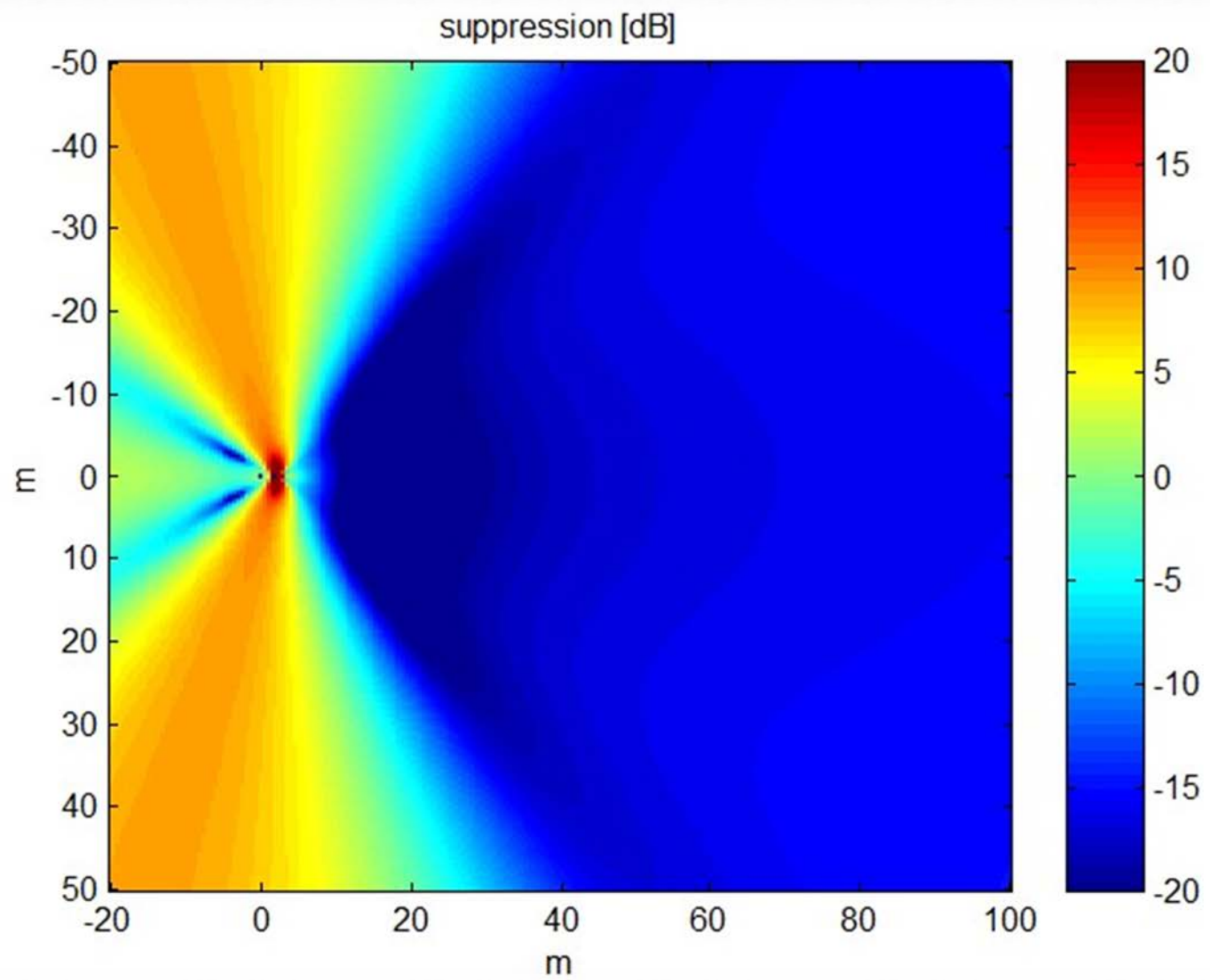



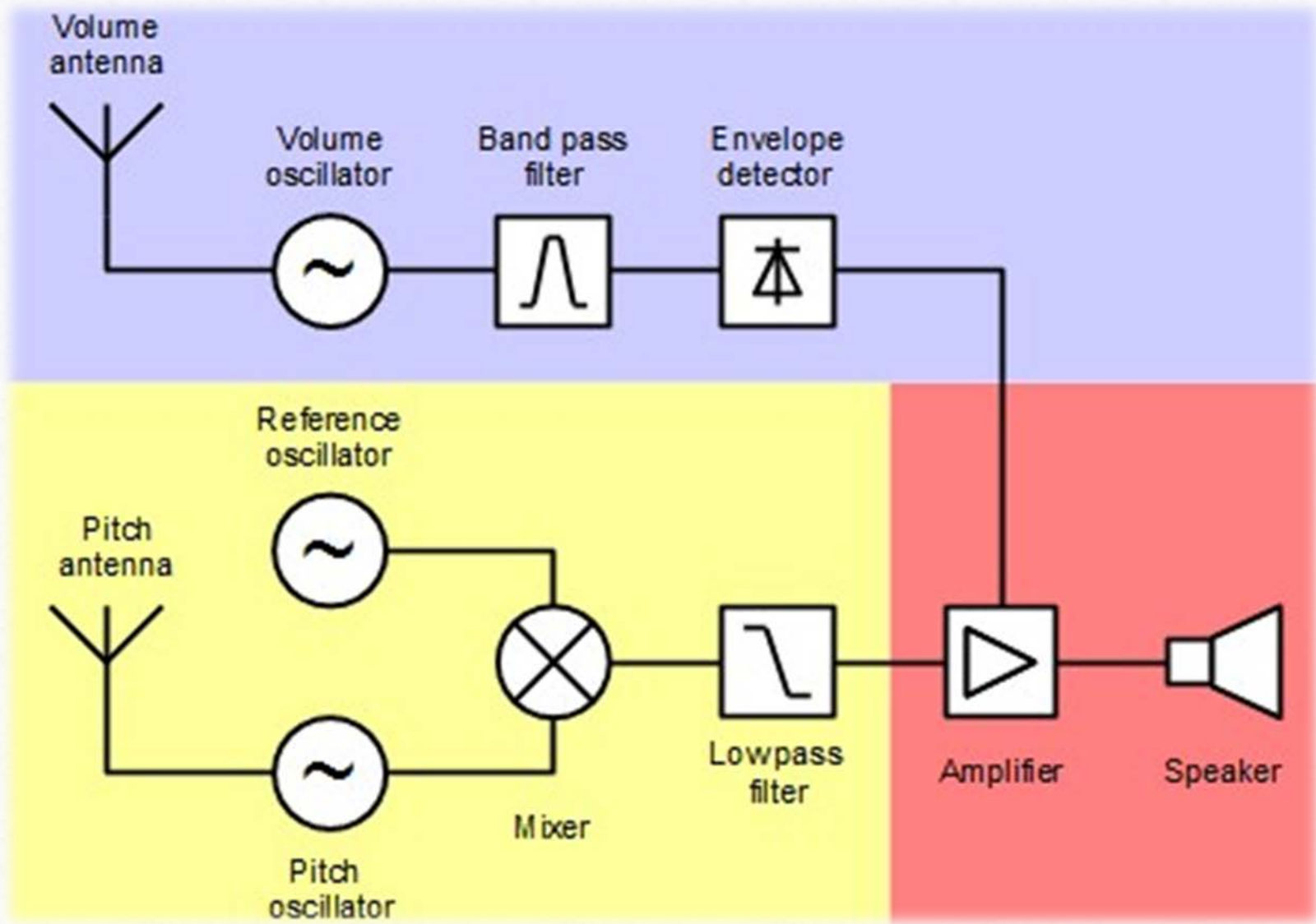



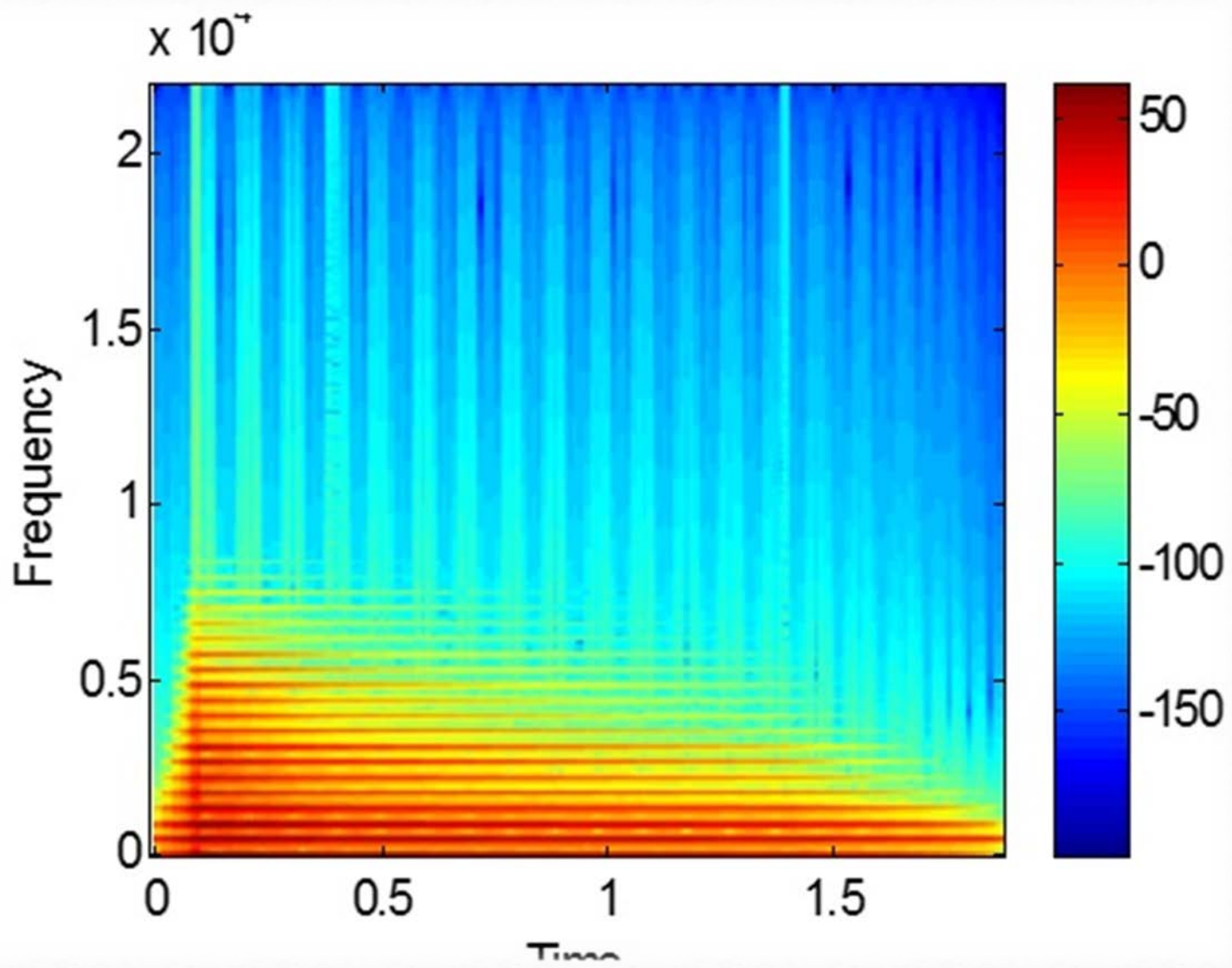



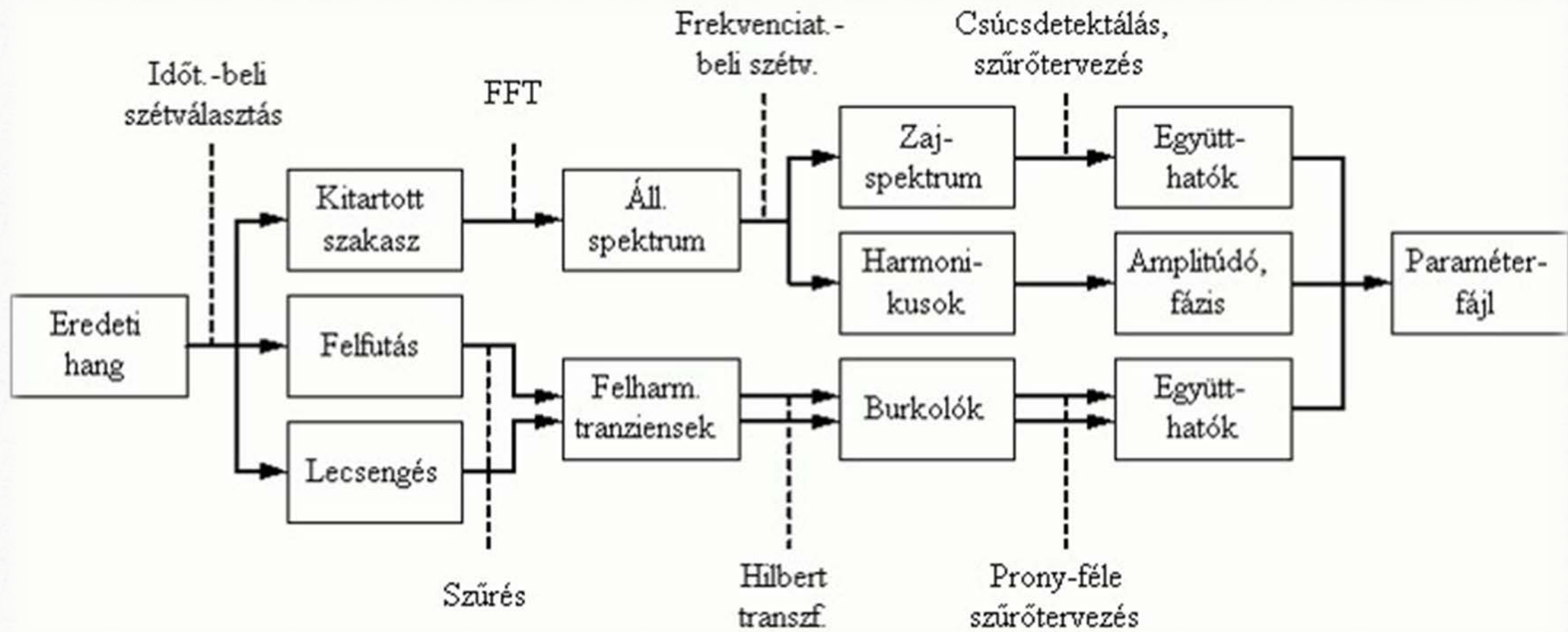



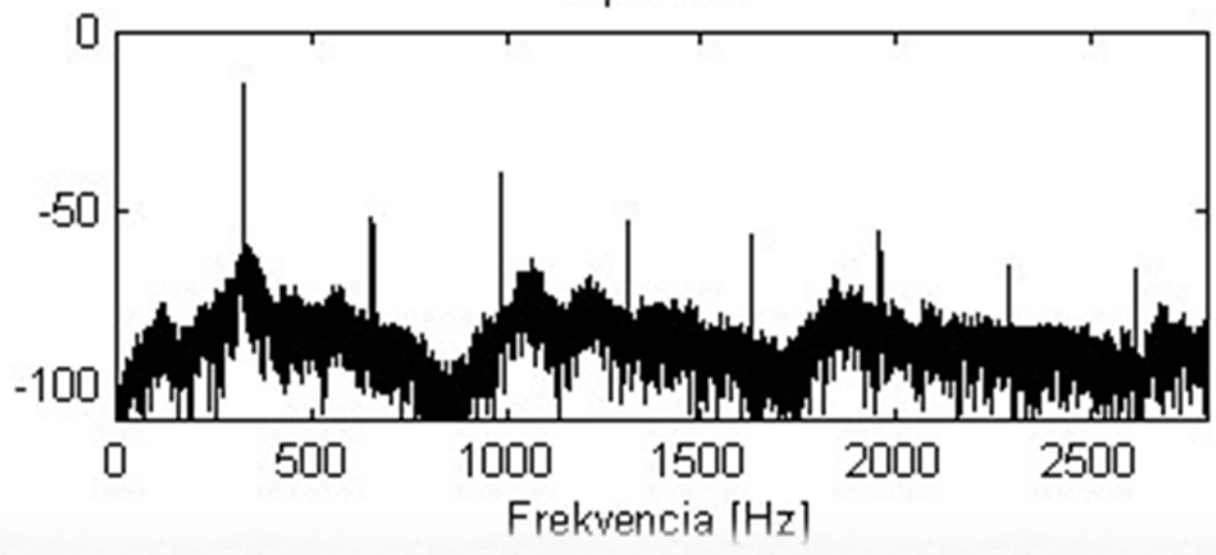
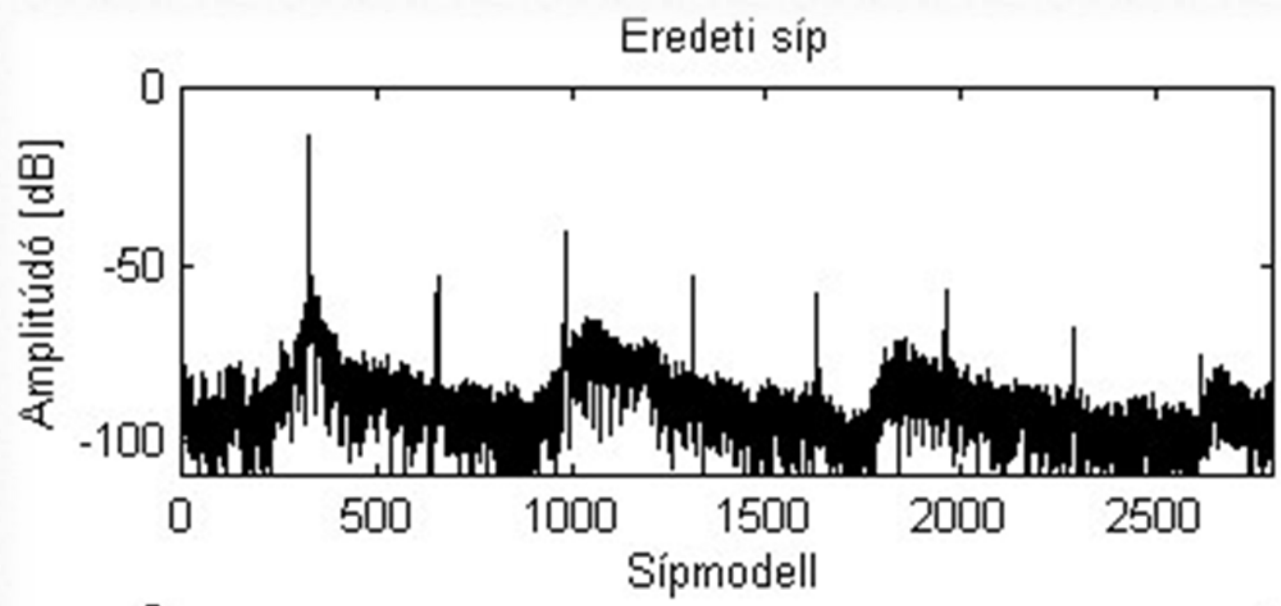



### Tranziens

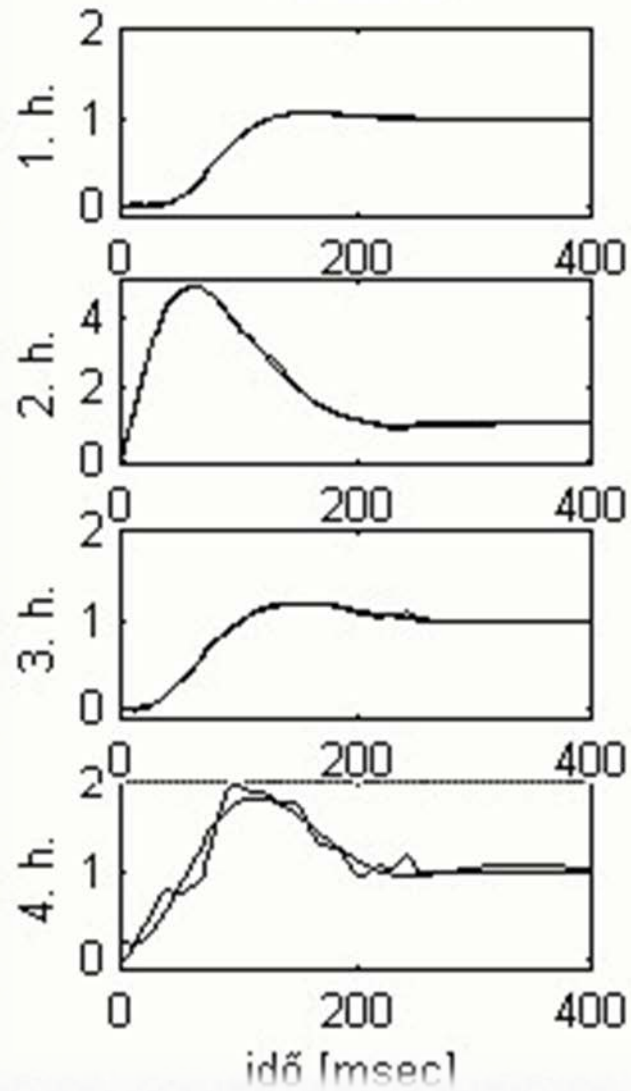

### berezgések

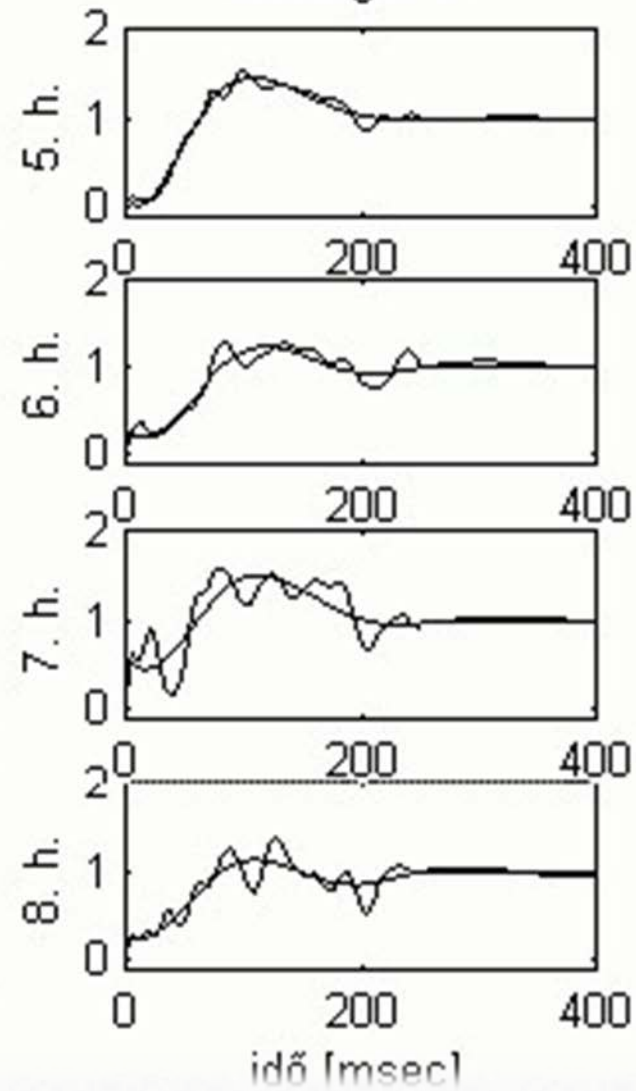











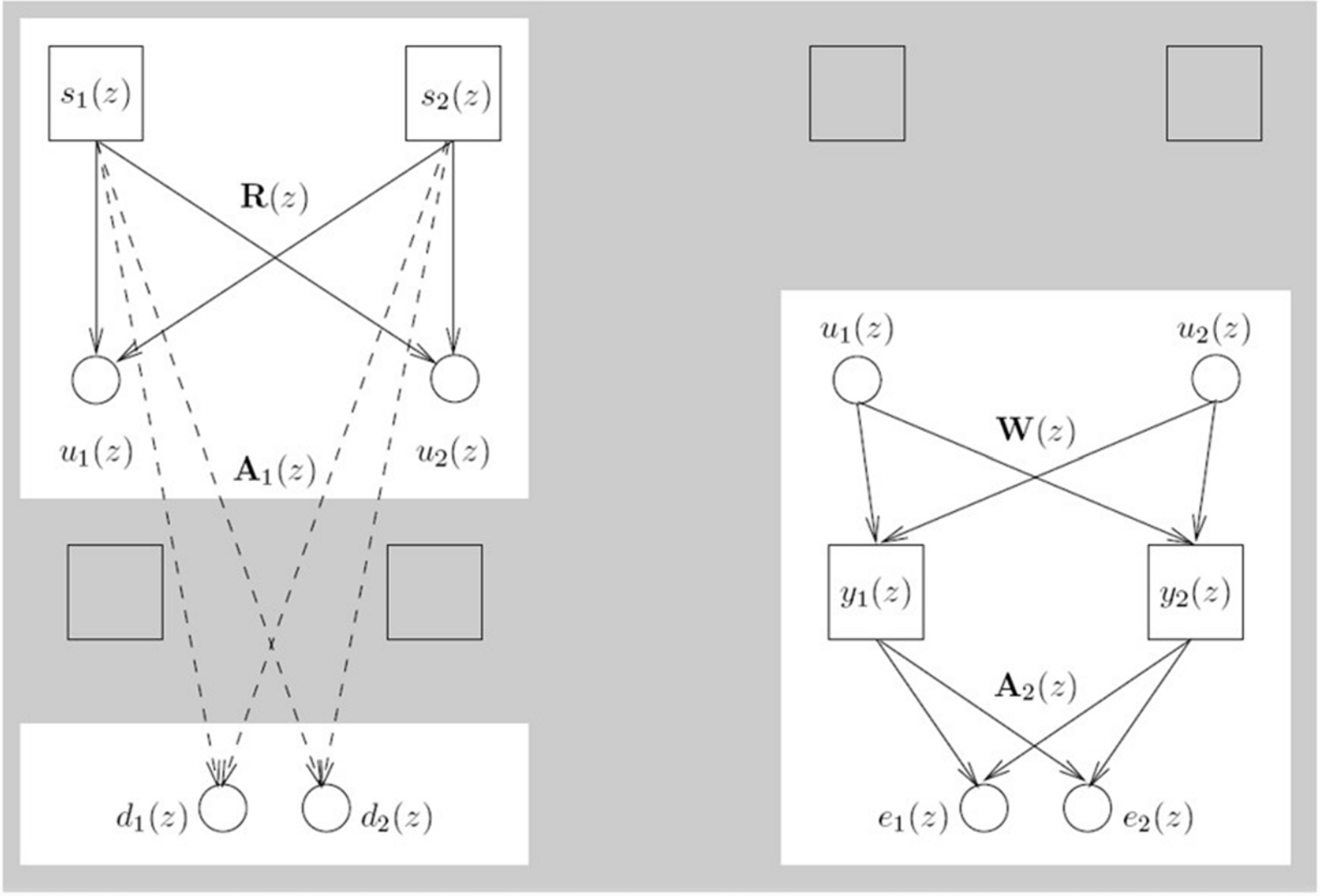



MICROPHONE



SOUND  
LEVEL  
METER

SOUND  
ANALYZER

HARMONIC  
SOURCE

AMPLI-  
TUDE

PHASE  
ANGLE

AMPLIFIER

LOUDSPEAKER



TRANSFORMER

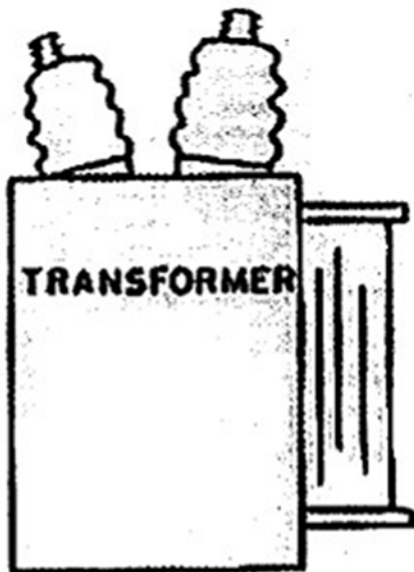



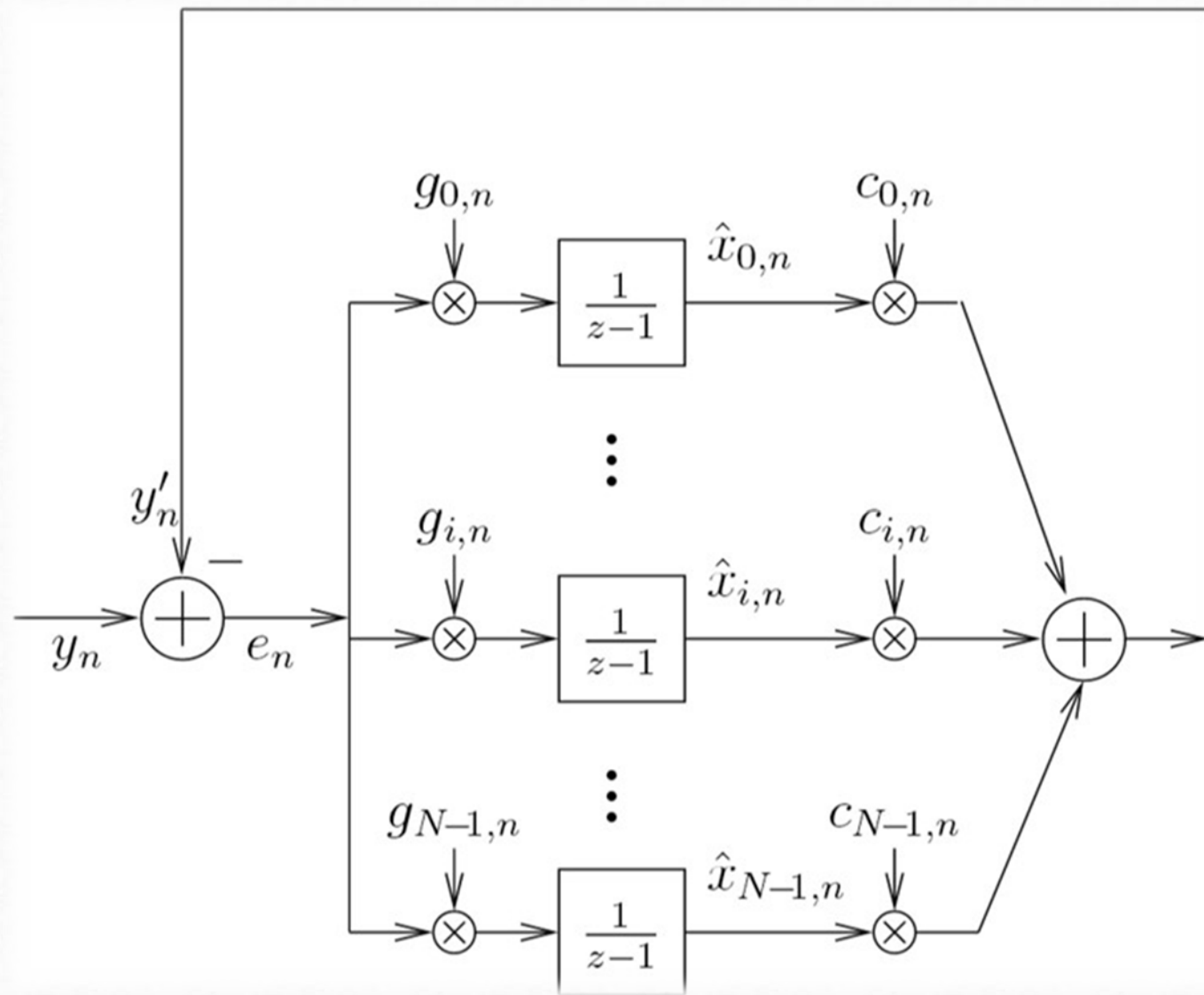







**ADSP-2100 FAMILY  
USER'S MANUAL**

**INCLUDES  
ADSP-2171  
ADSP-2181**



**ANALOG  
DEVICES**











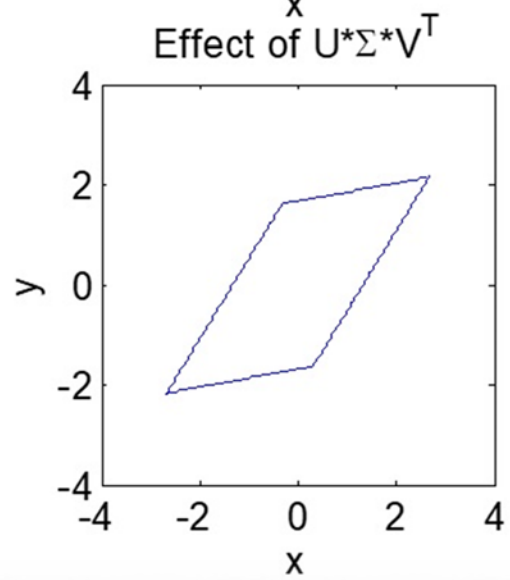
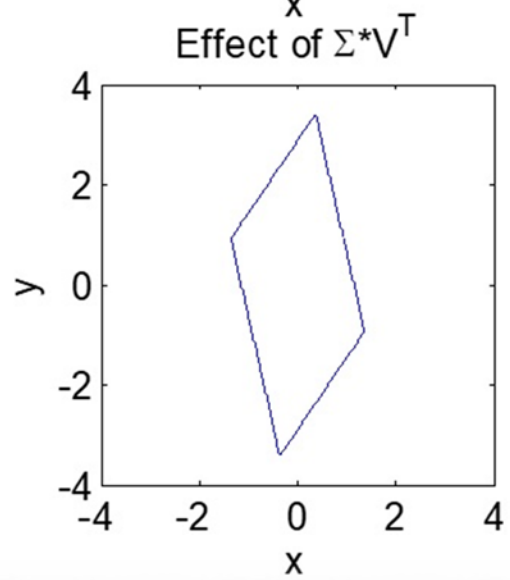
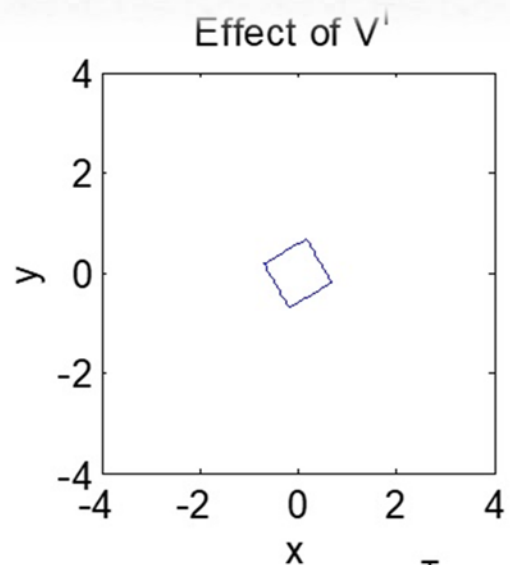
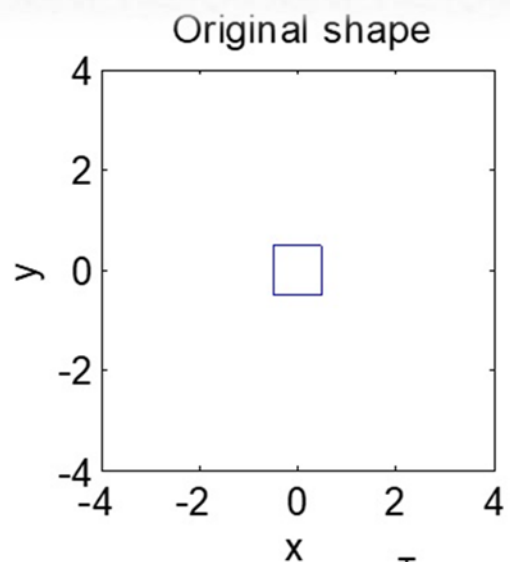



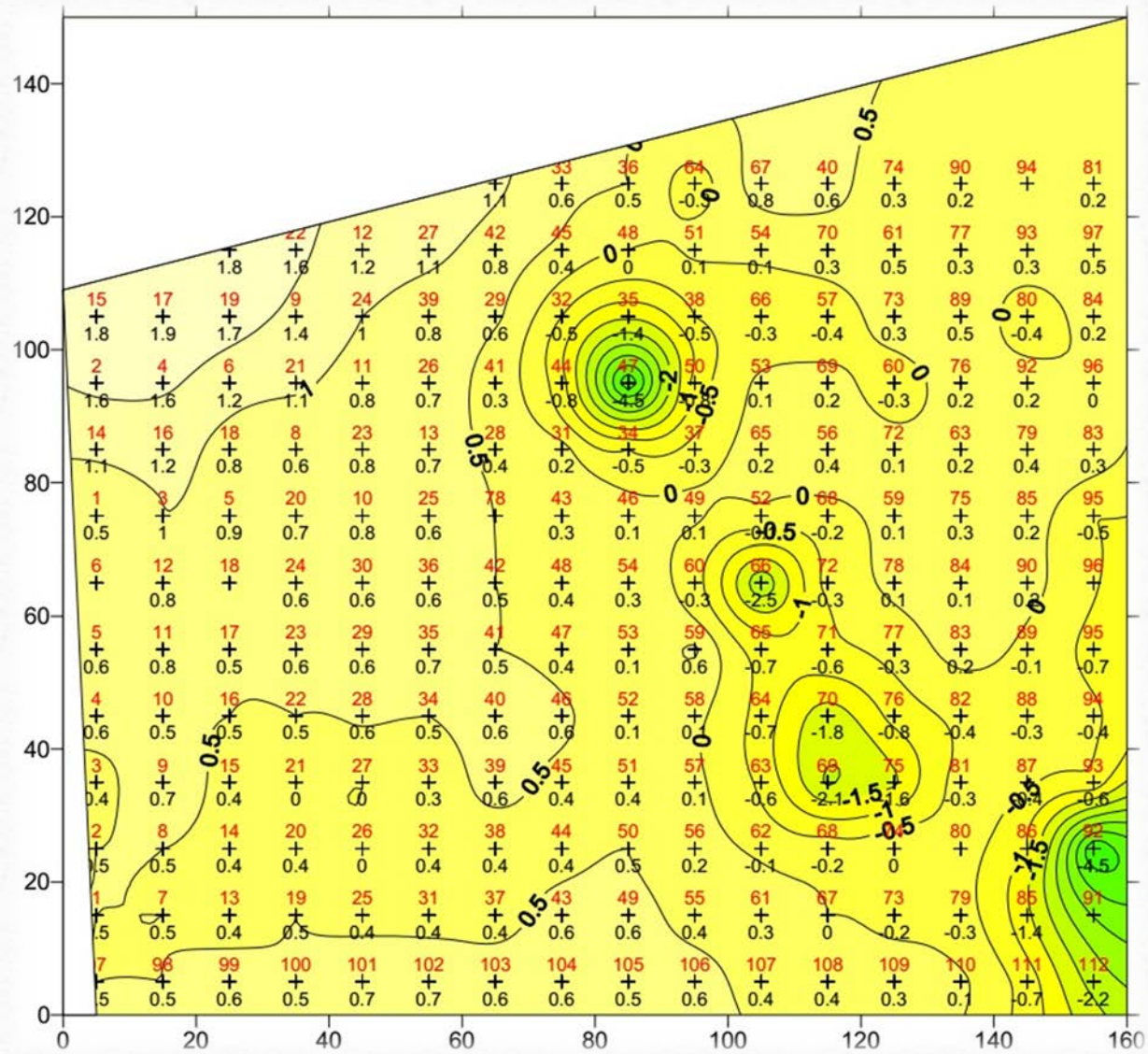







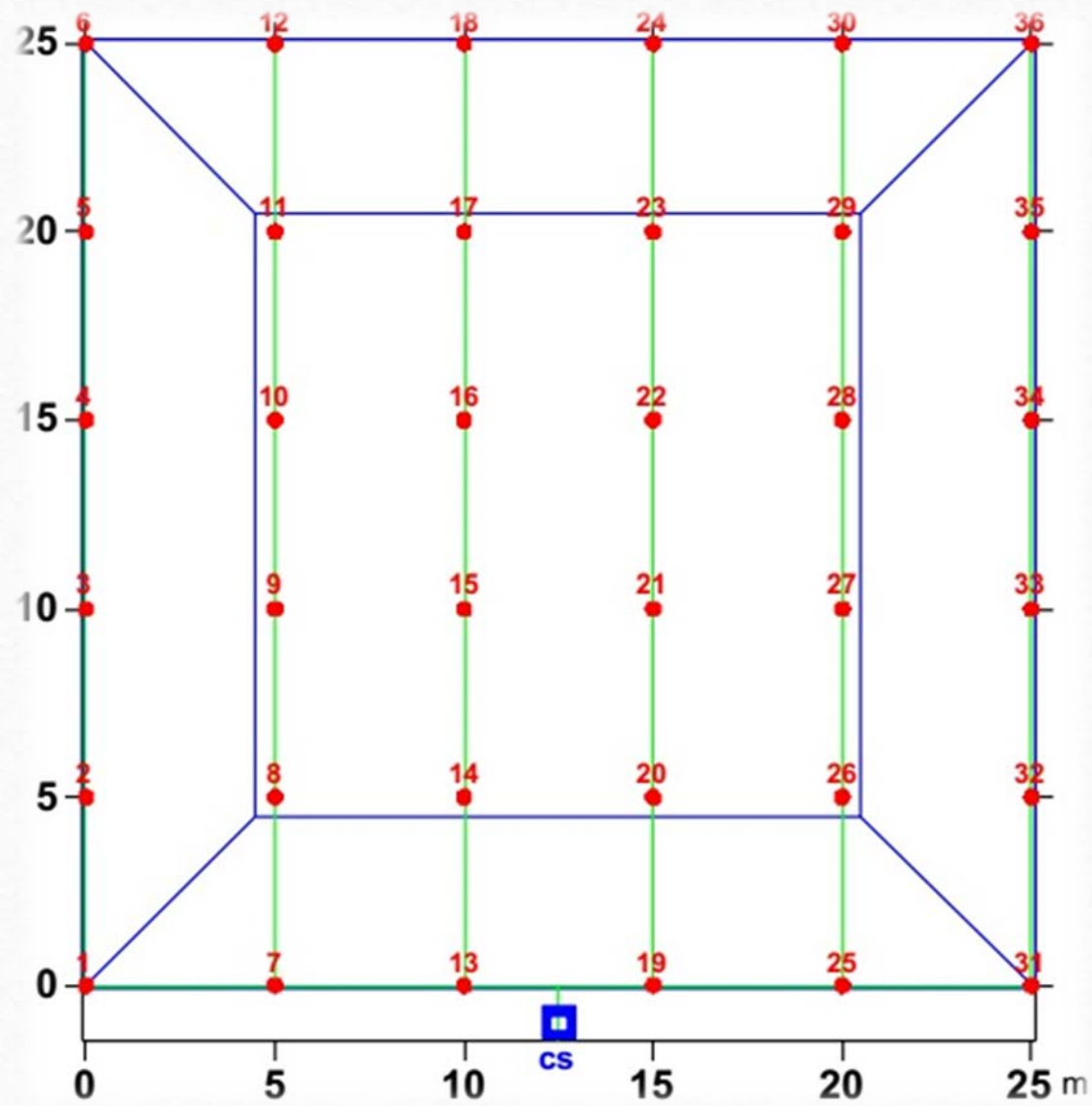



# Zongoramodell

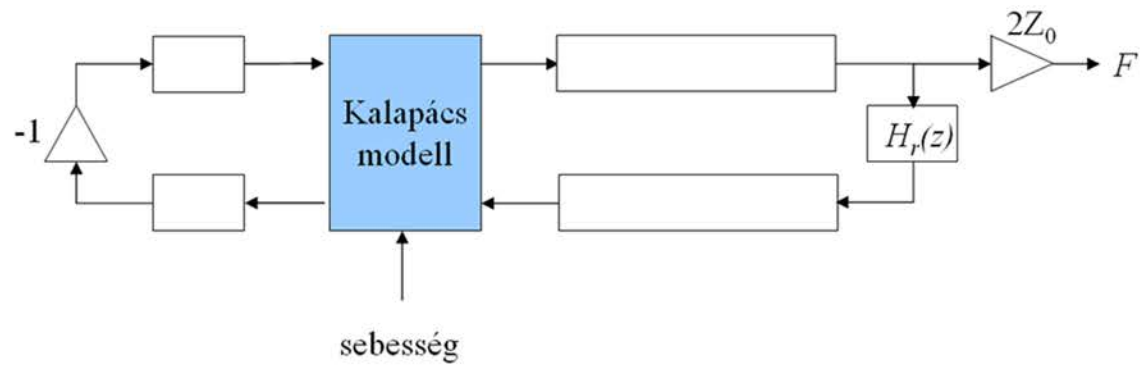
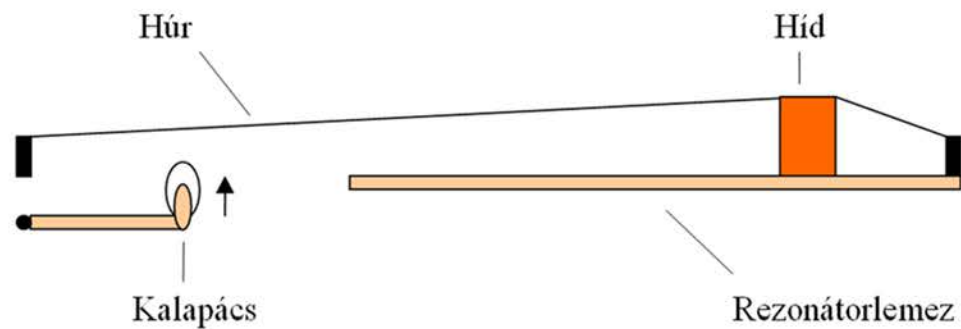



# Hegedűmodell

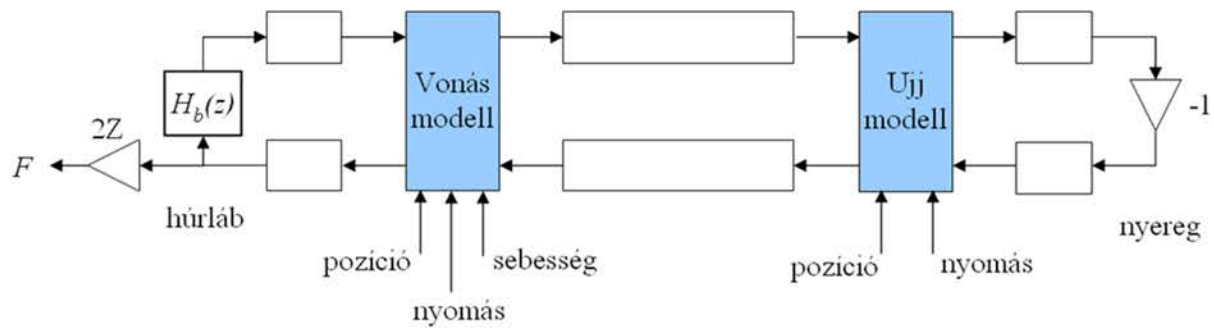
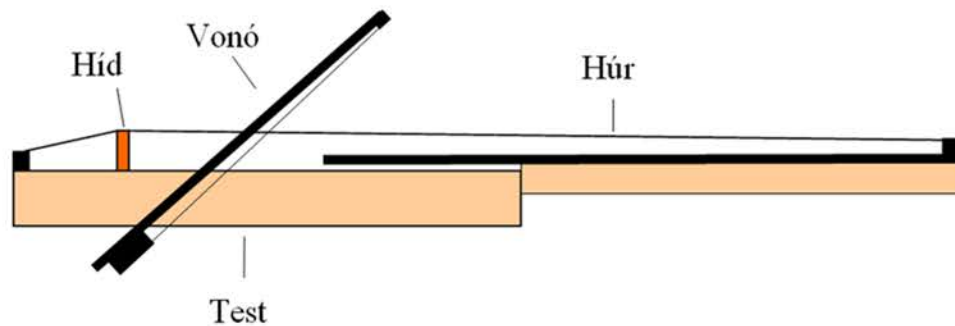



## Reflexió szűrő tervezése

Lecsengő húr analízise: specifikáció

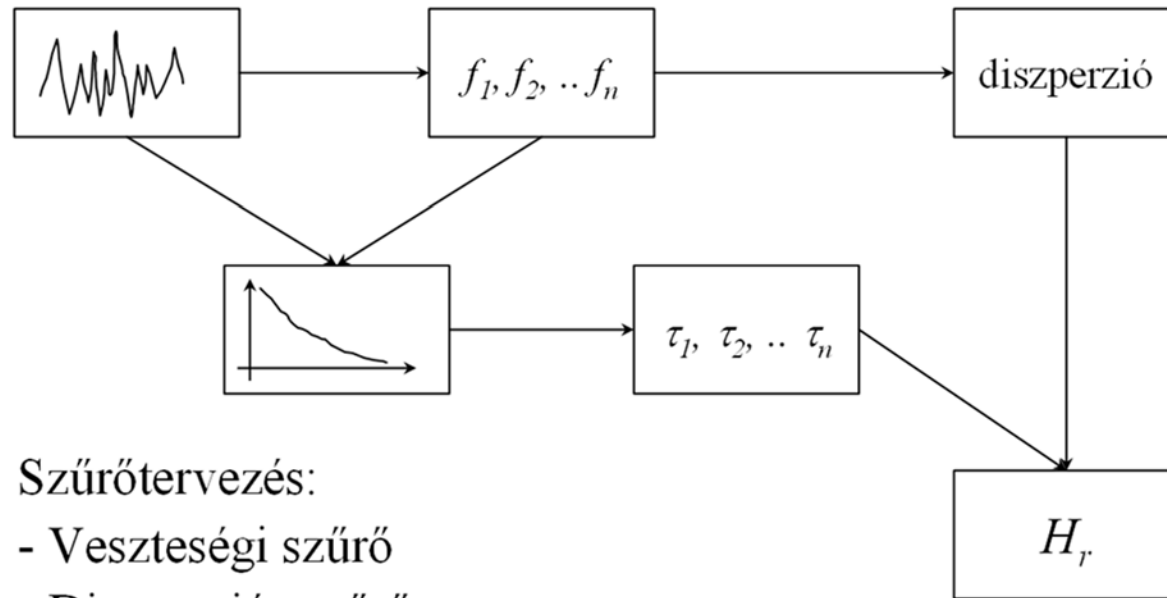

Szűrőtervezés:

- Veszteségi szűrő
- Diszperziós szűrő
- Törtrészkesleltető







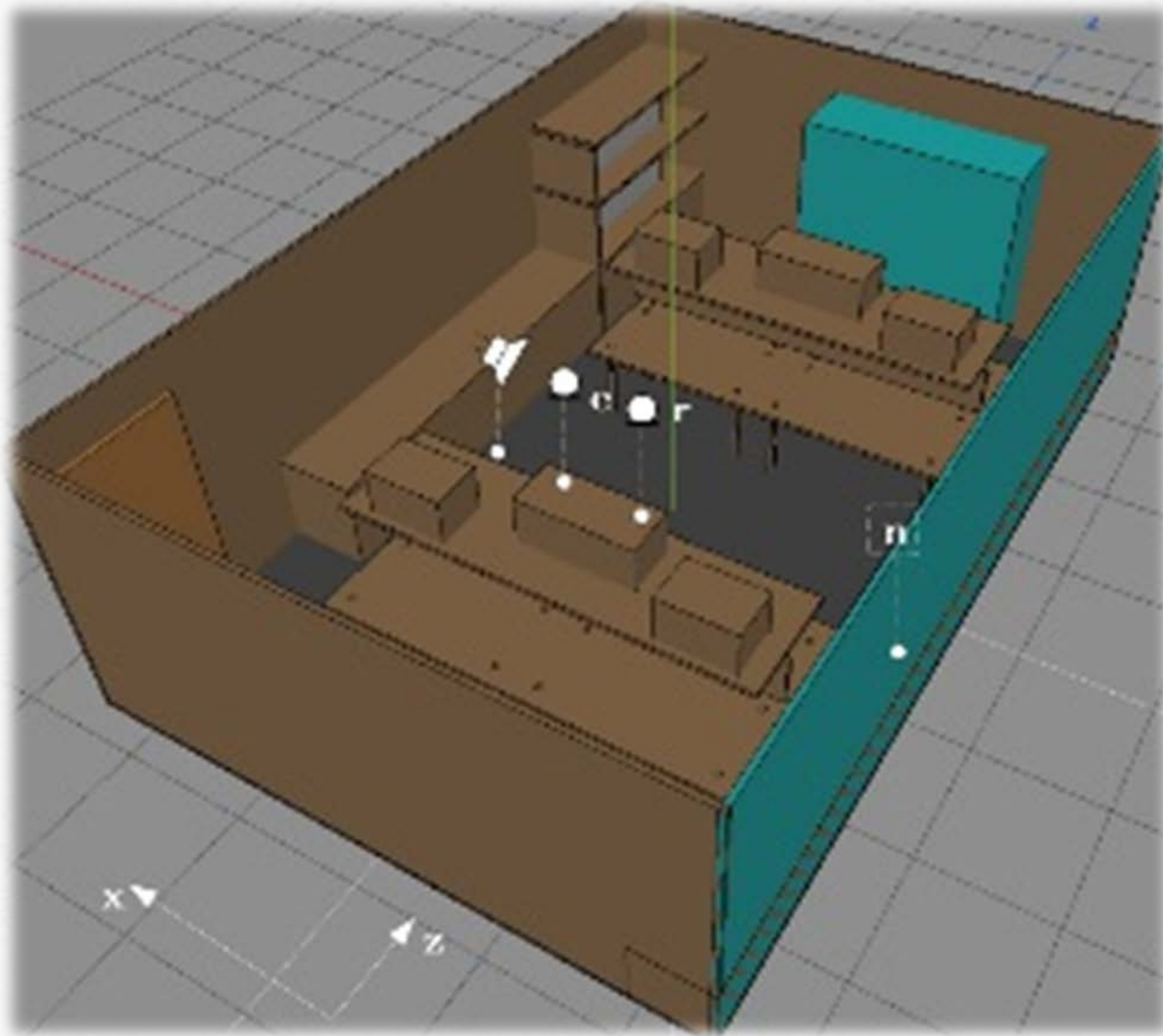



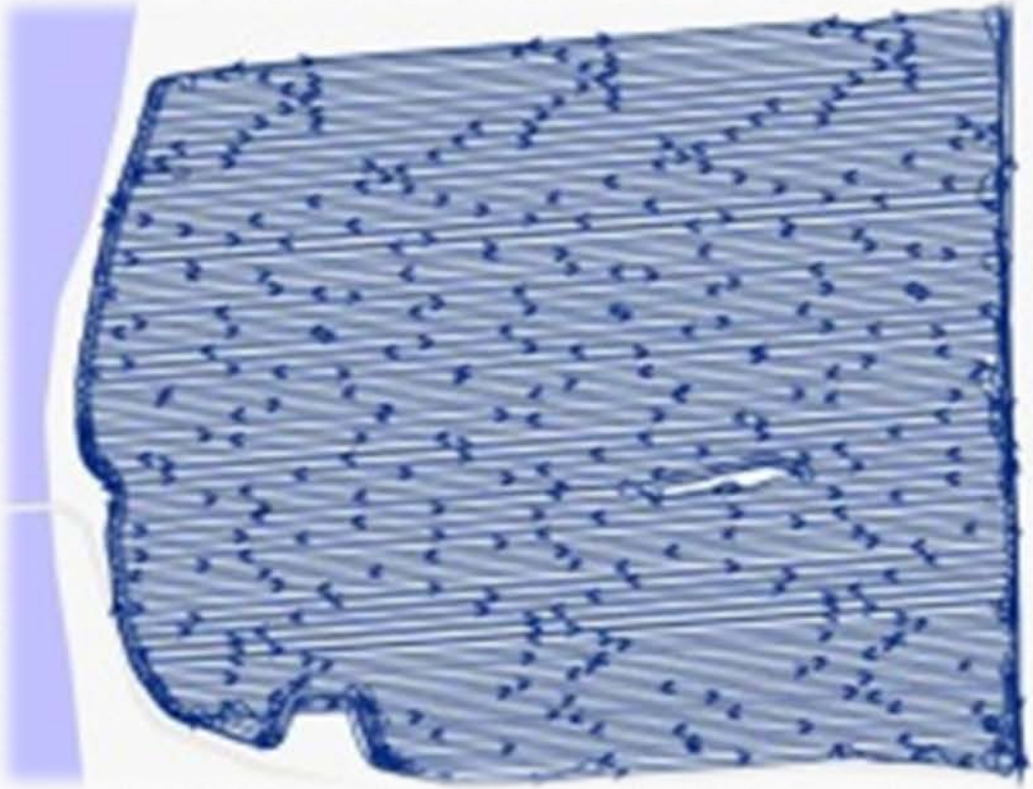



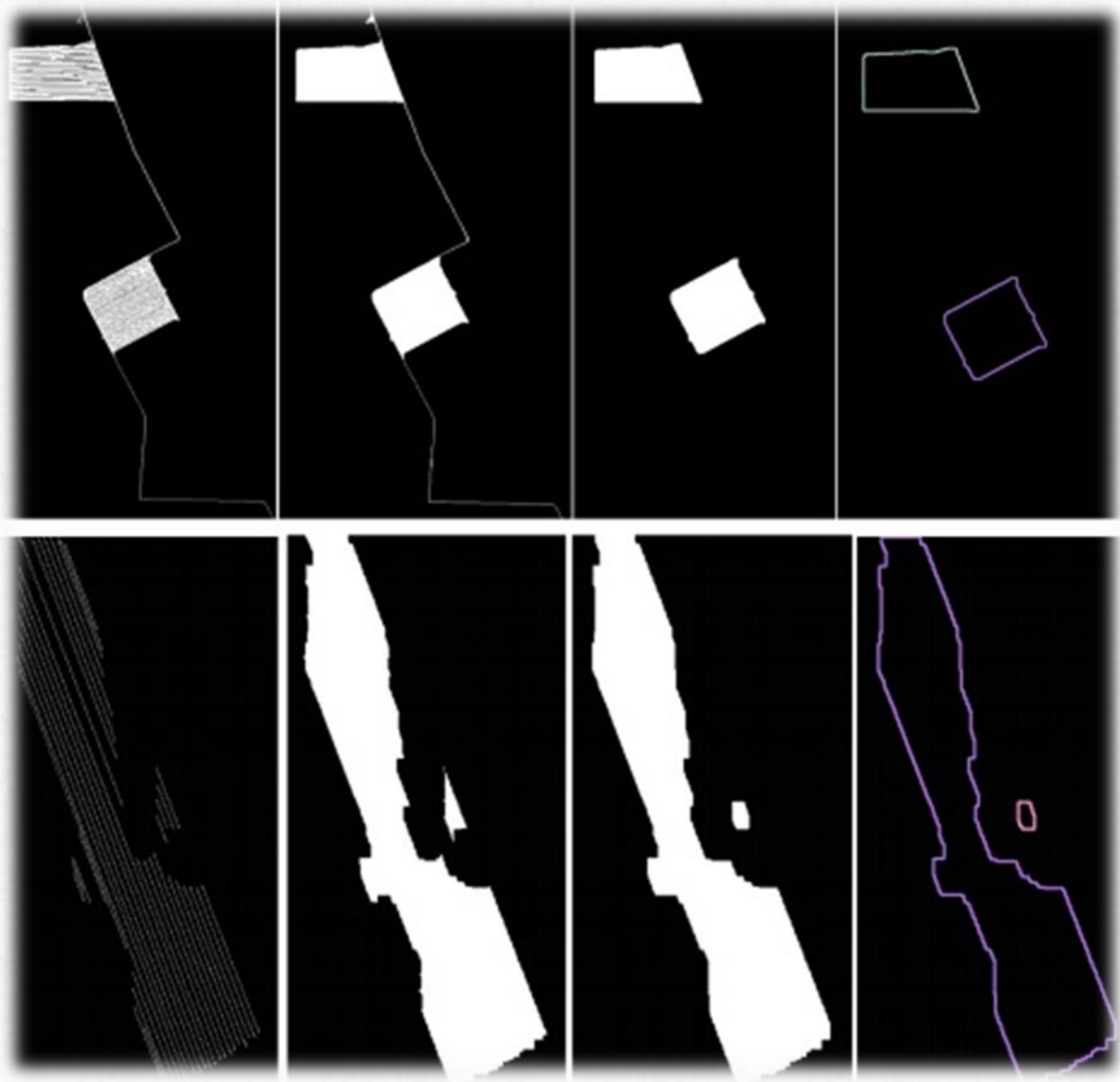



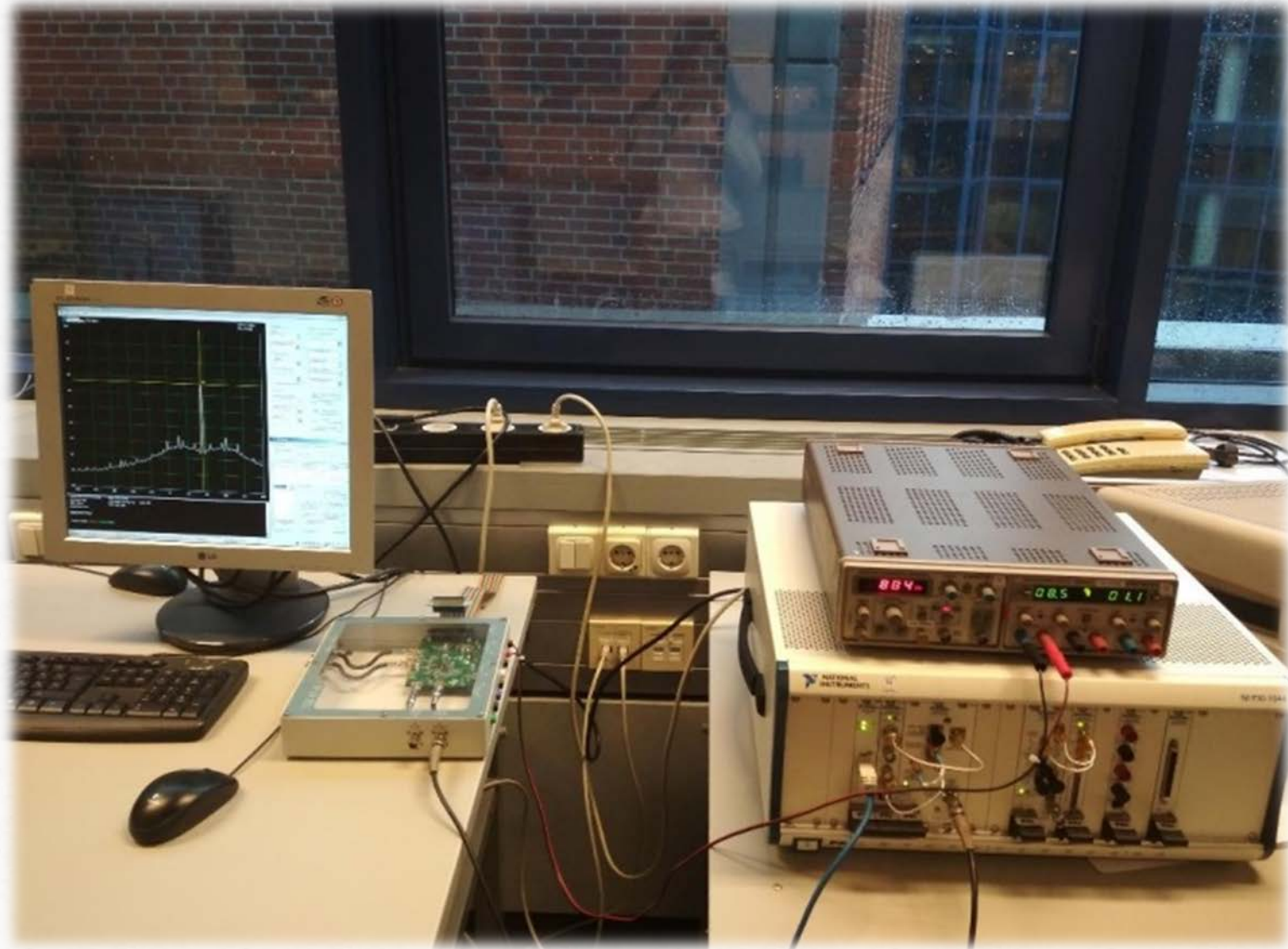



Bus/Signal

Trigger

- A0-2-CLK
- A1-3-DataIn
- A2-4-Strobe
- A3-5-TXData
- A4-6-Enable
- A5-7-Mode
- A6-11-RSSI
- A7-12-RXData

<input type="checkbox"/>	
<input type="checkbox"/>	
<input type="checkbox"/>	
<input type="checkbox"/>	
<input type="checkbox"/>	
<input type="checkbox"/>	
<input type="checkbox"/>	

